

C'SINK 82' X .535"
FOR 1/4" FLAT HEAD
SCREW (56 PLACES).

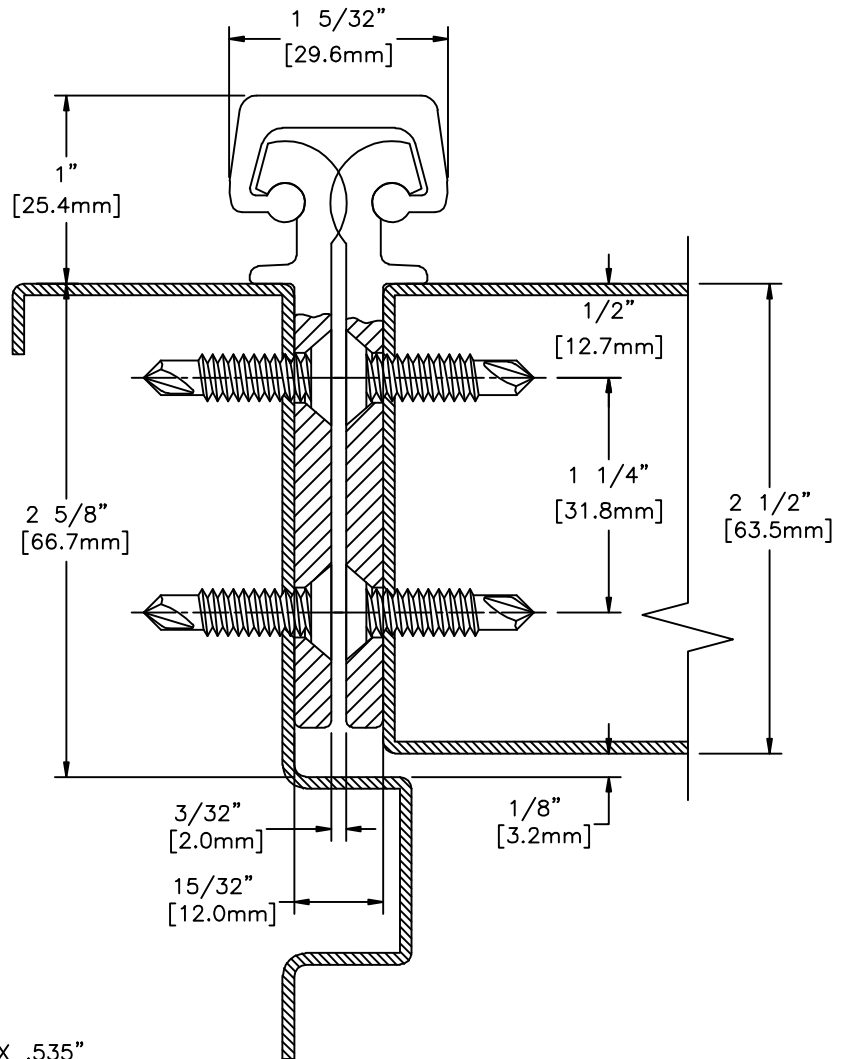

This application is intended for square edged doors only. For beveled edge doors, refer to the General Information section titled Door and Frame Dimensioning - Concealed Models



HAGER COMPANIES

HIGHWAY 78 WEST
P.O. BOX 3368
OXFORD, ALABAMA 36203

1200-650 95" HD

DATE 03-23-04 REV. DR. MRD SCALE None

FILENAME z:\roton\template\standard\1200-650.dwg

DRAWING NO. TS650095000000001