

TEMPLATE FOR FULL MORTISE CONTINUOUS GEARED ALUMINUM HINGE

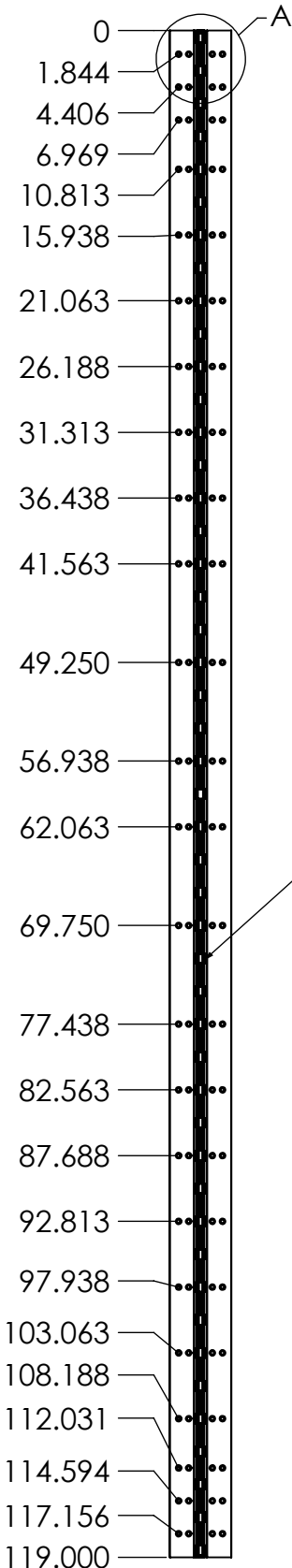

BEARINGS
47 PLACES

#12 FLAT
HEAD SCREW
96 PLACES

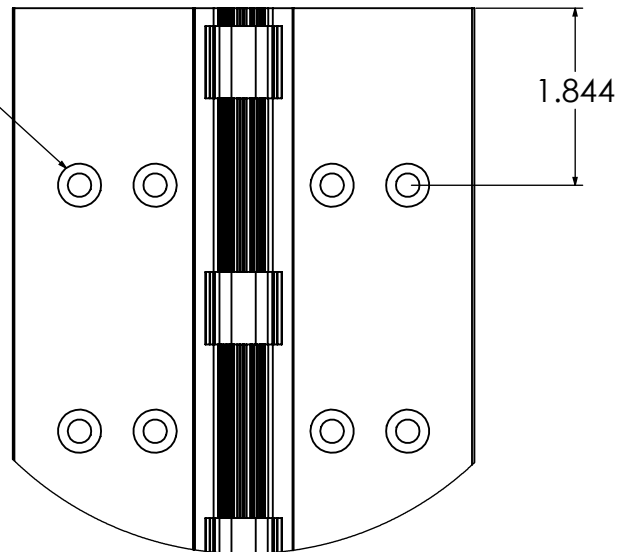
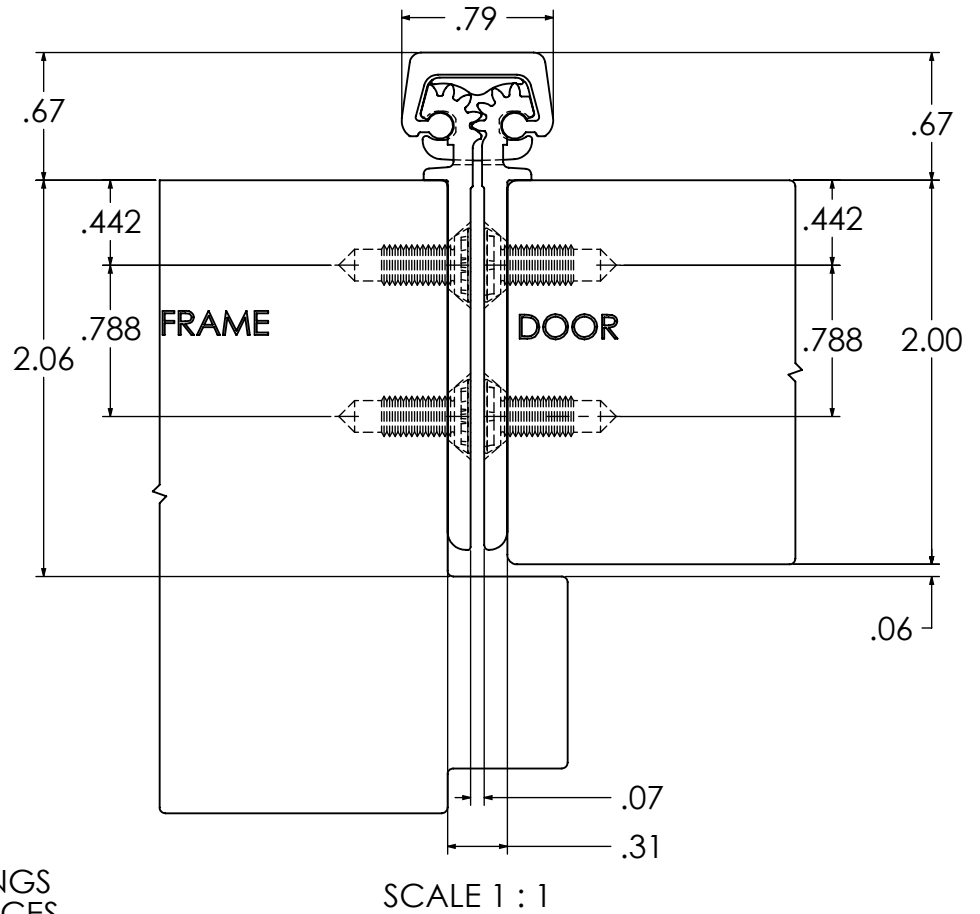

DETAIL A
SCALE 1 : 2