

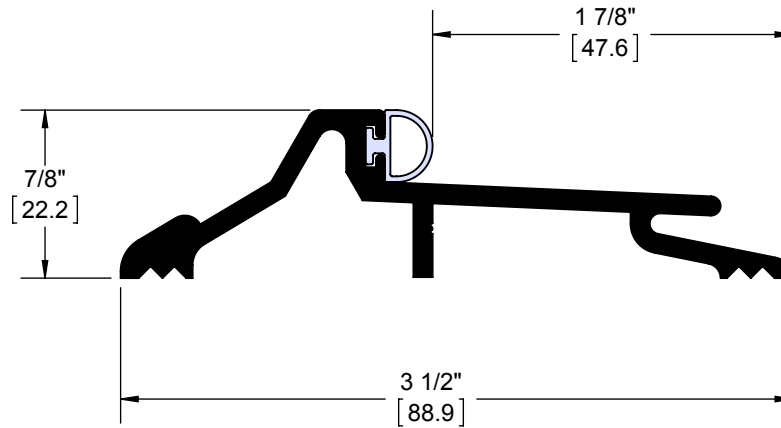

REV.	DESCRIPTION	ECO NO.	DATE
-	INITIAL CHECK IN	-	10/31/2014



#10 x 1-1/2" Flat Phillips Head Wood Screws (Factory Provided)

 <p>PROPRIETARY & CONFIDENTIAL THE INFORMATION CONTAINED IN THIS DRAWING IS THE SOLE PROPERTY OF HAGER COMPANIES. ANY REPRODUCTION IN PART OR AS A WHOLE WITHOUT THE WRITTEN PERMISSION OF HAGER COMPANIES IS PROHIBITED.</p>	<p>HAGER RESERVES THE RIGHT TO MAKE DESIGN CHANGES WITHOUT NOTICE. CALL HAGER ENGINEERING AT 1-800-325-9995 FOR THE LATEST REVISION DATE OF TEMPLATE.</p>	DRAWN	DRS	10/16/2014	<p>599S PANIC THRESHOLD</p>		
		ENG. APPR.	-	-			
		MATERIAL	Material <not specified>			Q.A.	
		FINISH	-			<p>TOLERANCES: FRACTIONAL: ±0.015" ANGULAR: MACH: ± 1° BEND: ±1° TWO PLACE DECIMAL: ±0.01" THREE PLACE DECIMAL: ±0.004"</p>	
DO NOT SCALE DRAWING		SIZE	DWG. NO.		REV.		
		A	S-TW00246		-		
		SCALE: 1:1	WEIGHT: 0.23		SHEET 1 OF 1		