

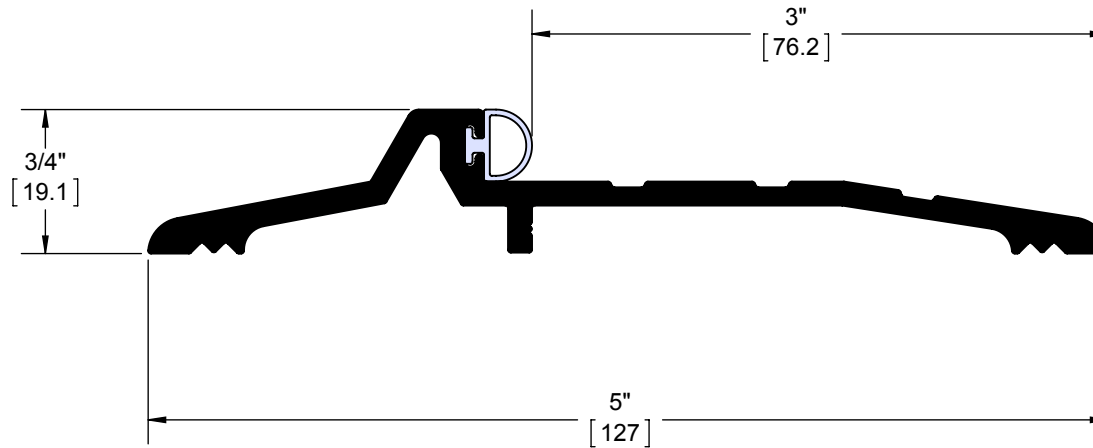

REV.	DESCRIPTION	ECO NO.	DATE
-	INITIAL CHECK IN	-	10/31/2014



#10 x 1-1/2" Flat Phillips Head Wood Screws (Factory Provided)

 <p>PROPRIETARY & CONFIDENTIAL THE INFORMATION CONTAINED IN THIS DRAWING IS THE SOLE PROPERTY OF HAGER COMPANIES. ANY REPRODUCTION IN PART OR AS A WHOLE WITHOUT THE WRITTEN PERMISSION OF HAGER COMPANIES IS PROHIBITED.</p>	<p>HAGER RESERVES THE RIGHT TO MAKE DESIGN CHANGES WITHOUT NOTICE. CALL HAGER ENGINEERING AT 1-800-325-9995 FOR THE LATEST REVISION DATE OF TEMPLATE.</p>	<p>DRAWN</p>	<p>DRS</p>	<p>10/16/2014</p>	<p>552S PANIC THRESHOLD</p>			
		<p>MATERIAL</p> <p>Material <not specified></p>	<p>ENG. APPR.</p> <p>-</p>	<p>Q.A.</p>				<p>TOLERANCES:</p> <p>FRACTIONAL: ±0.015"</p> <p>ANGULAR: MACH: ± 1° BEND: ±1°</p> <p>TWO PLACE DECIMAL: ±0.01"</p> <p>THREE PLACE DECIMAL: ±0.004"</p>
		<p>FINISH</p> <p>-</p>	<p>DO NOT SCALE DRAWING</p>			<p>SIZE</p> <p>A</p>	<p>DWG. NO.</p> <p>S-TW00232</p>	<p>REV.</p> <p>-</p>
		<p>SCALE: 1:1</p>					<p>WEIGHT: 0.31</p>	<p>SHEET 1 OF 1</p>