

TEMPLATE FOR FULL MORTISE CONTINUOUS GEARED ALUMINUM HINGE

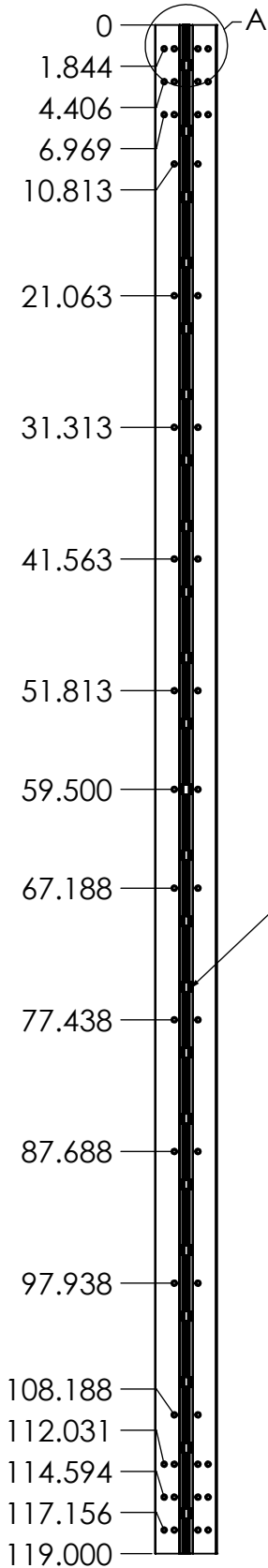

BEARINGS
23 PLACES

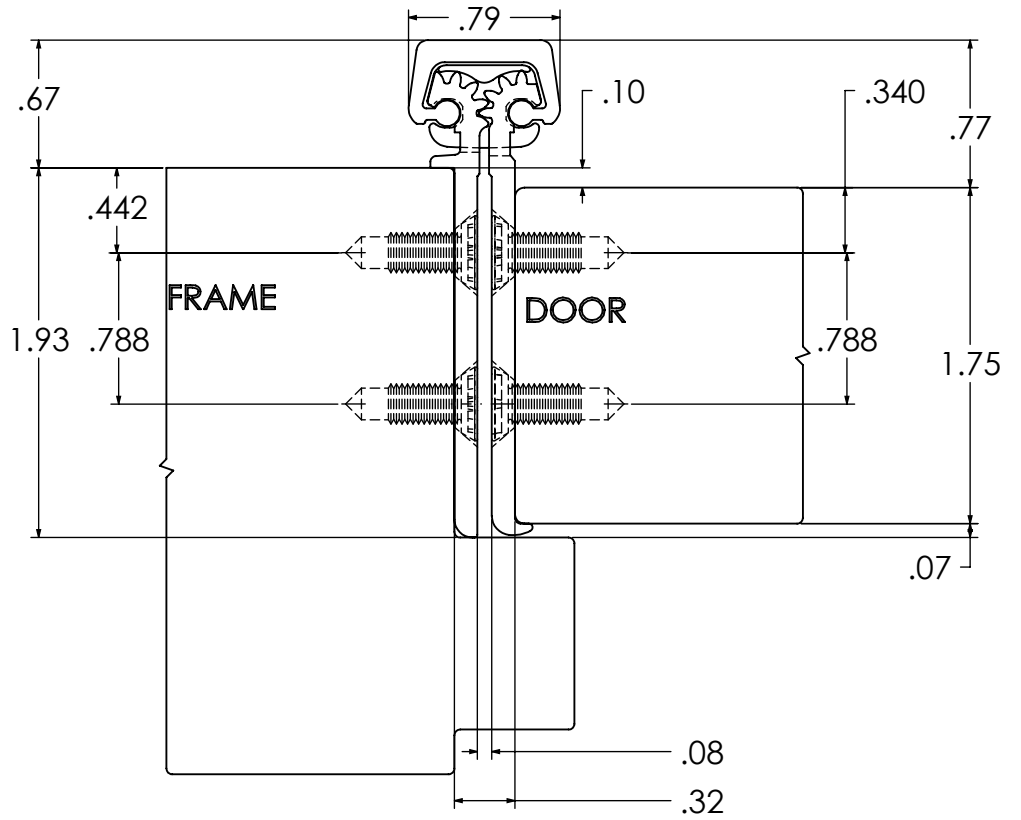

SCALE 1 : 1

#12 FLAT
HEAD SCREW
46 PLACES

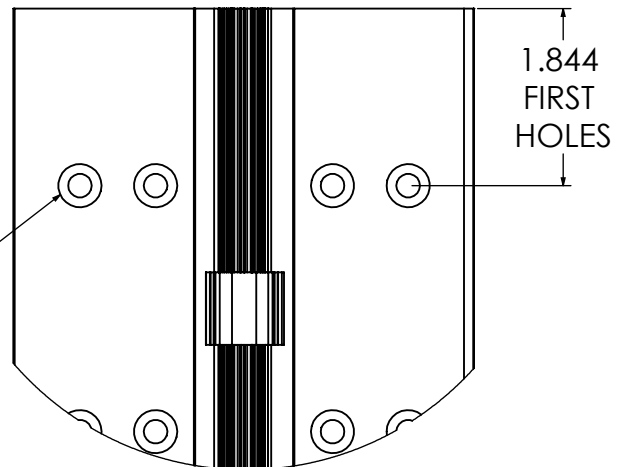

DETAIL A
SCALE 1 : 2