

TEMPLATE FOR FULL MORTISE CONTINUOUS GEARED ALUMINUM HINGE

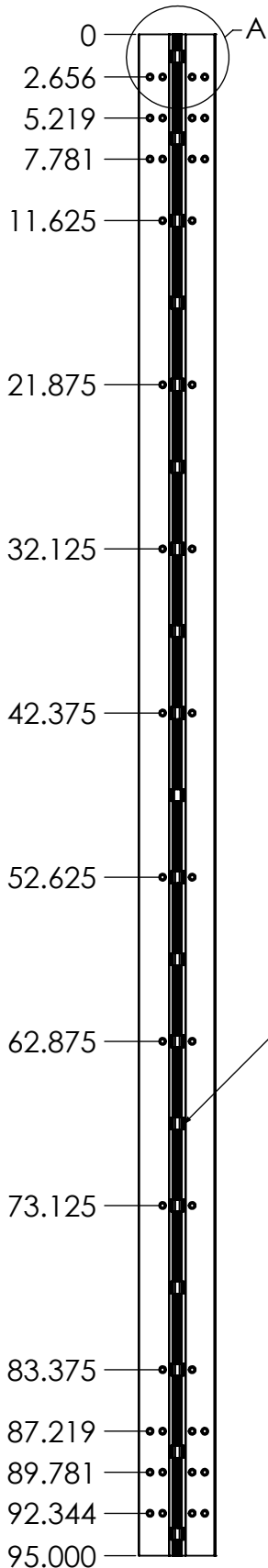

BEARINGS
19 PLACES

#12 FLAT
HEAD SCREW
40 PLACES

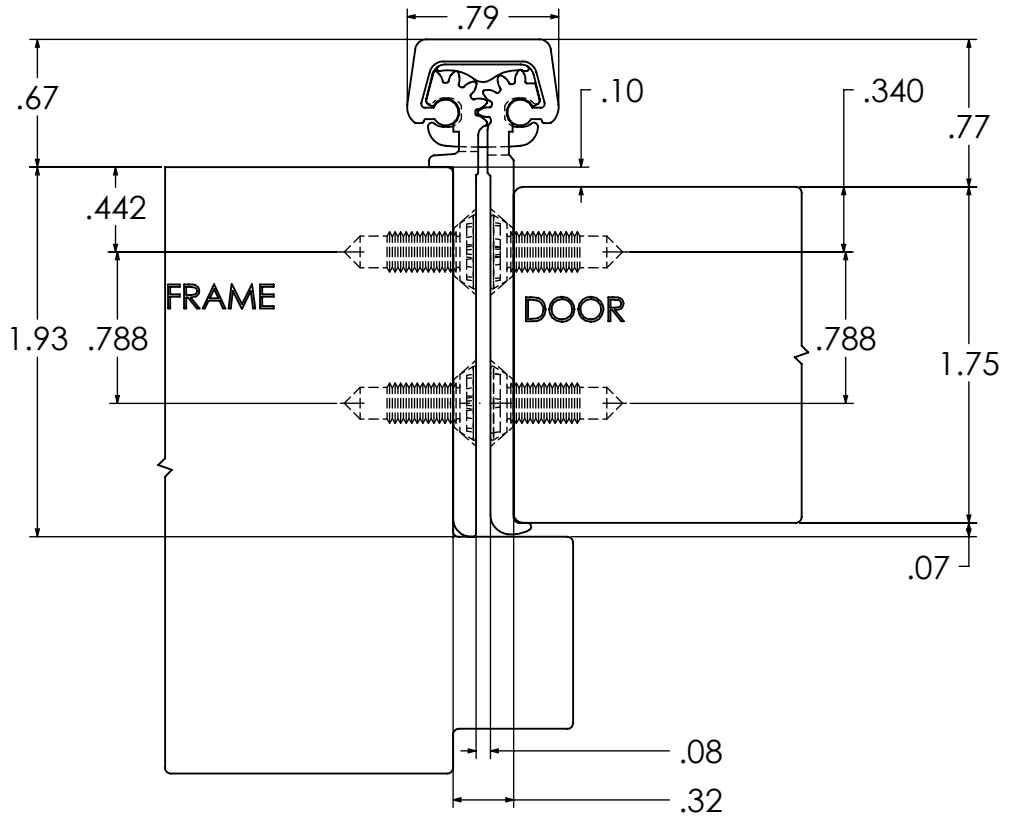

SCALE 1 : 1

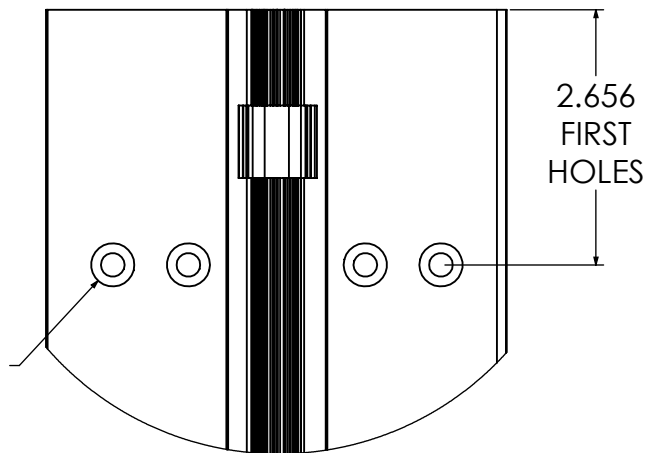

DETAIL A
SCALE 1 : 2