

TEMPLATE FOR FULL MORTISE CONTINUOUS GEARED ALUMINUM HINGE

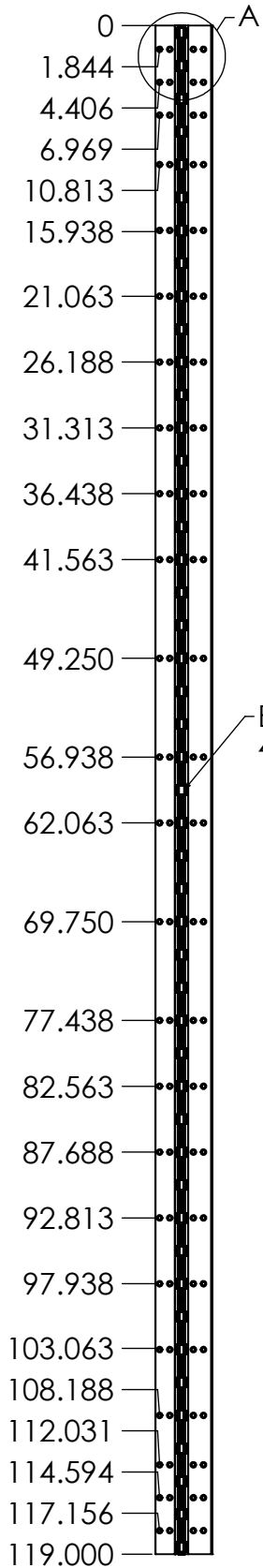

BEARINGS  
47 PLACES

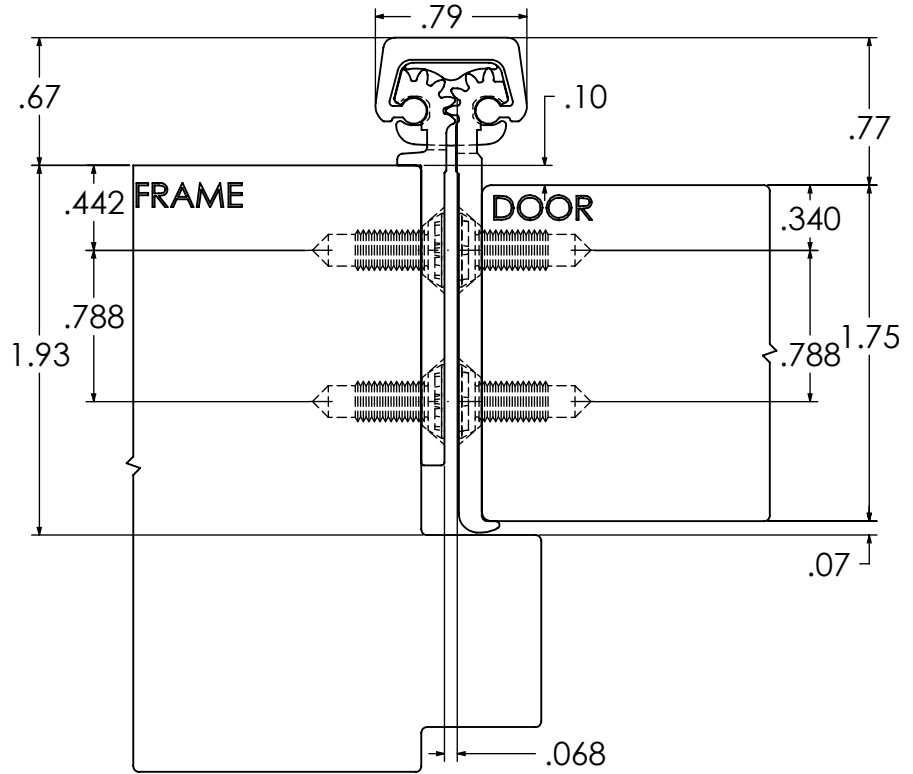

SCALE 1 : 1

#12 FLAT  
HEAD SCREW  
96 PLACES

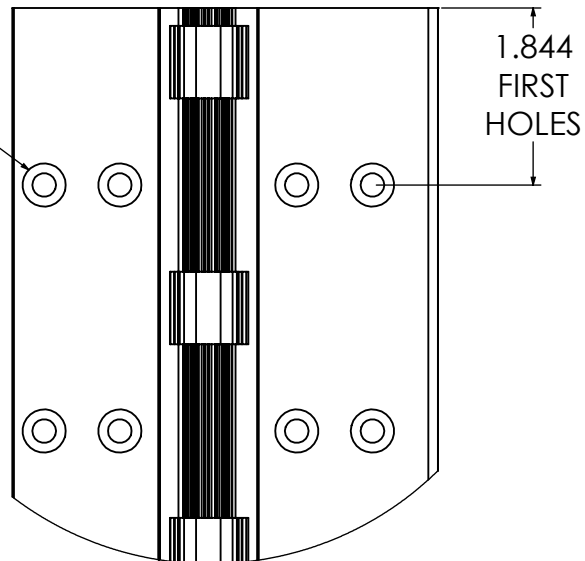

DETAIL A  
SCALE 1 : 2