

TEMPLATE FOR FULL MORTISE CONTINUOUS GEARED ALUMINUM HINGE

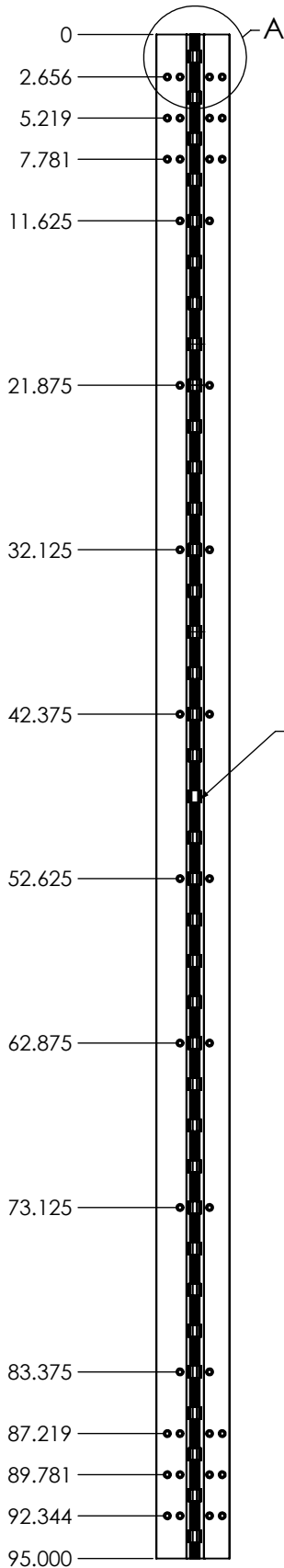

BEARINGS
37 PLACES

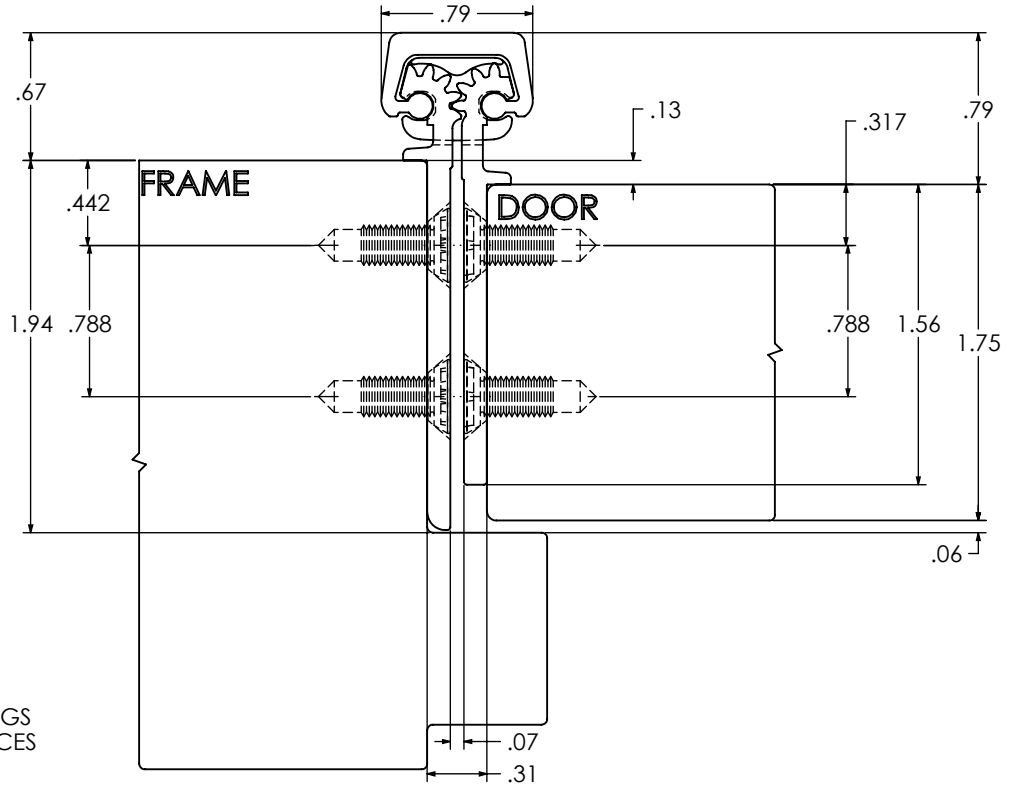

SCALE 1 : 1

#12 FLAT HEAD SCREW
40 PLACES

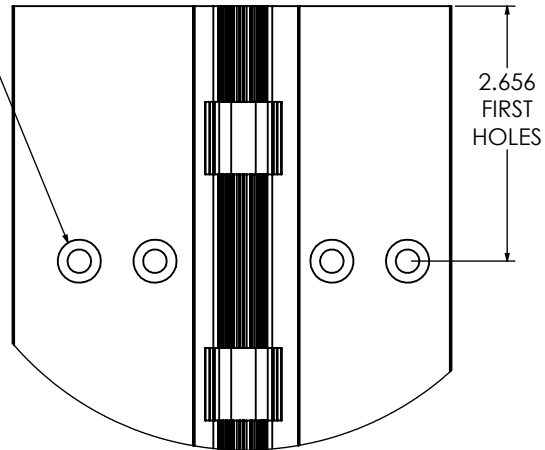

DETAIL A
SCALE 1 : 2