

TEMPLATE FOR FULL MORTISE CONTINUOUS GEARED ALUMINUM HINGE

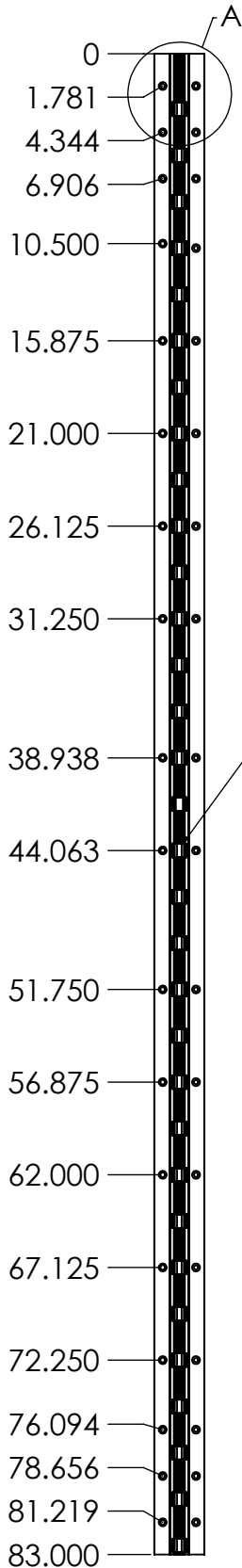

BEARINGS
32 PLACES

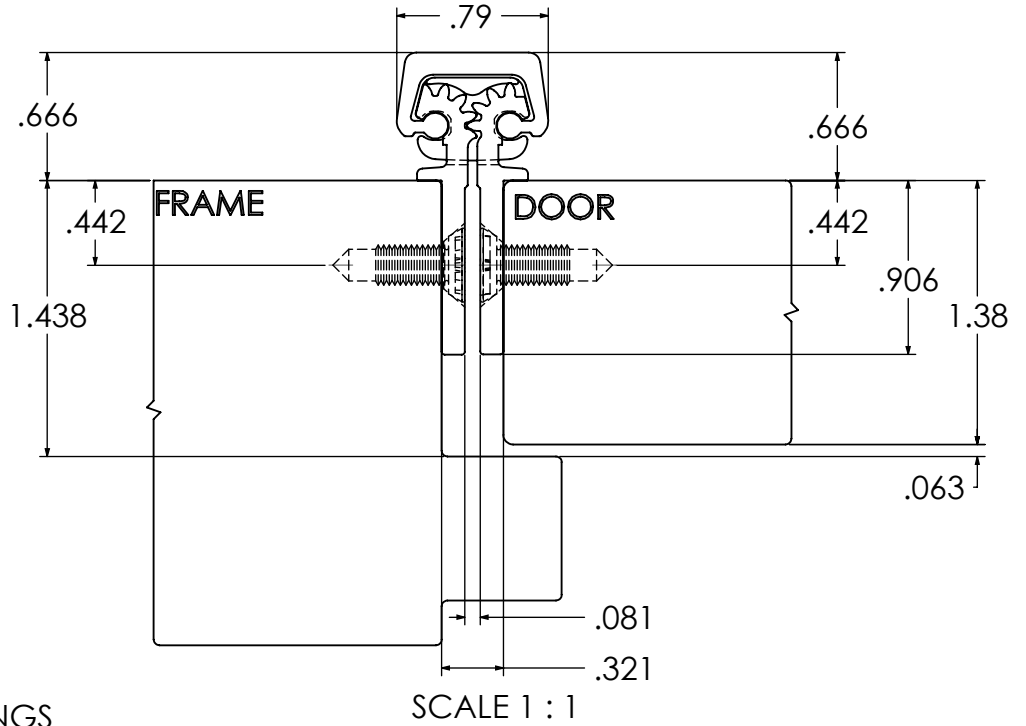

#12 FLAT
HEAD SCREW
36 PLACES

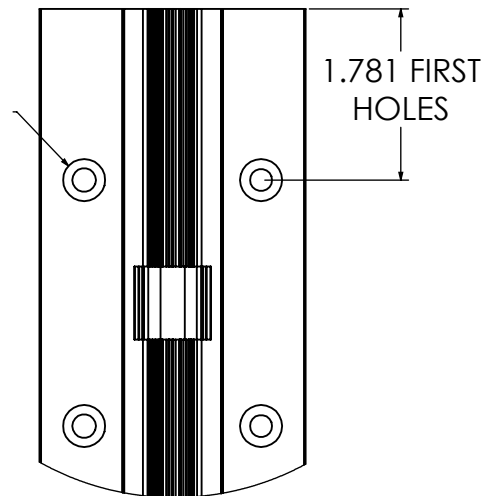

DETAIL A
SCALE 1 : 2