

TEMPLATE FOR FULL MORTISE CONTINUOUS GEARED ALUMINUM HINGE

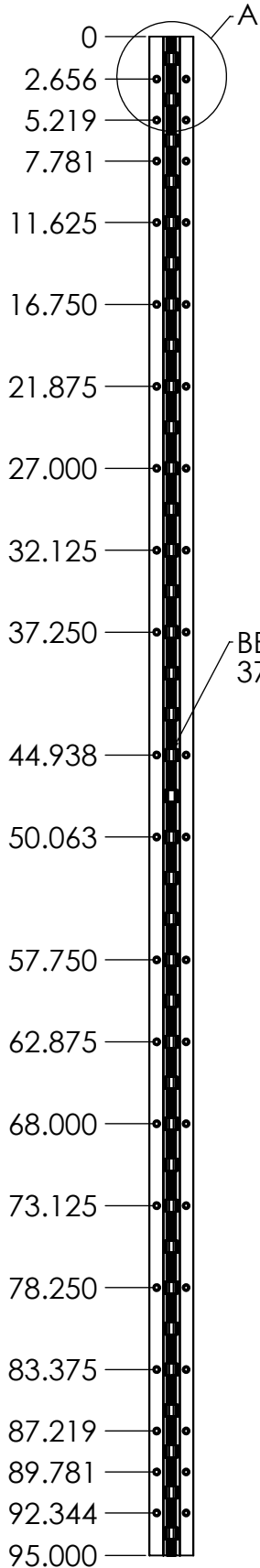

BEARINGS
37 PLACES

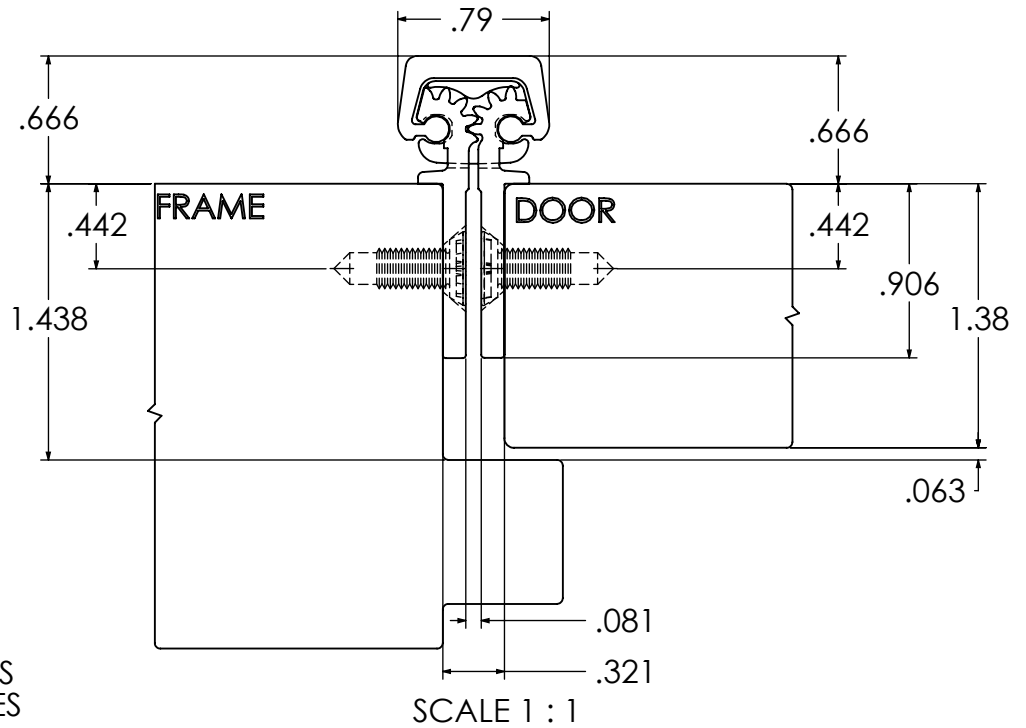

#12 FLAT
HEAD SCREW
40 PLACES

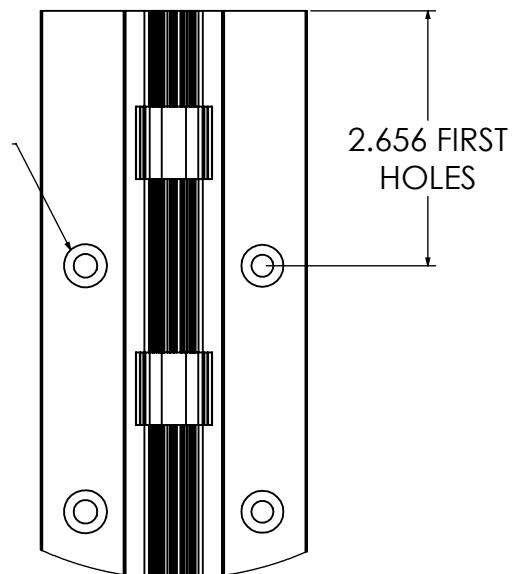

DETAIL A
SCALE 1 : 2