

The Hager PIR Motion Sensor combines a passive-infrared detector with relay output to allow control of door ingress and egress in request-to-exit (REX) applications. It is UL Listed as an access control device under the UL 294 standard, It is for indoor use only, the PIR Sensor is not designed for use as the primary means of exit for emergency egress

The PIR Sensor can be ceiling or wall mounted over the door and the detection pattern can be tailored via vertical aim adjustment and/or masking of the detection pattern,

The relay output consists of two form "C" contacts that can be adjusted to latch from 0.5 second to 64 seconds. Resettable or non-resettable can be selected for the latch time. The relay can also be programmed to fail safe (doors unlocked) or fail secure (doors locked) mode in the event of a power loss.

## Product specifications:

- Voltage Input: 12 VDC or VAC; 24 VDC or 24VAC
- Current Draw: 16mA@ 12VDC (see Current Ratings on page 4)
- REX Detector Output: 2 Form C relay contacts rated 2A 30VDC/AC maximum for DC resistive loads
- Indicator: Green LED for PIR detection
- Relay Latch Duration: Adjustable from 0.5 second to 64 seconds
- Timer Modes: resettable (cumulative) or non-resettable (counting)
- Modes: Fail Safe (Doors Unlocked) or Fail Secure (Doors Locked)
- Mounting Locations: Above door(s) controlled on door frame, wall or ceiling
- Mounting Height: 7' to 15'
- Housing: High impact ABS plastic
- Dimensions: 7"W X 1.75"H X 1.88"D (178W X 44H X 48Dmm)
- Operating Temperature: -20° F to 120° F (-29° C to 49° C)
- Relative Humidity: 0-85%
- RFI Immunity: 26MHz to 1000 MHz @ 50 V/m (FCC)

## Wiring:

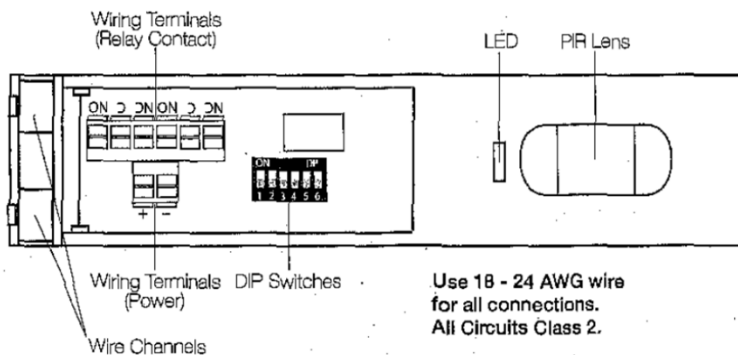

All wiring connections should be made and verified before any power is connected to the detector. All power, including standby battery if used, should be disconnected.

Connect wires to terminals as follows:

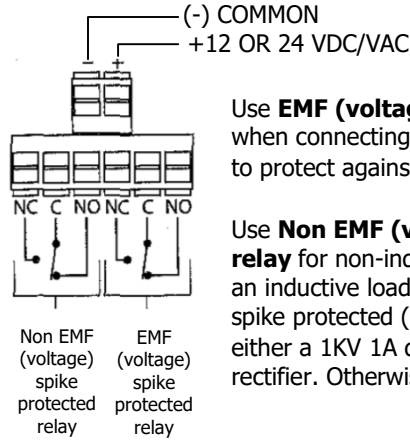

Use **EMF (voltage) spike-protected relay** when connecting inductive loads to the detector to protect against possible harmful EMF spikes.

Use **Non EMF (voltage) spike-protected relay** for non-inductive loads. When connecting an inductive load to the detector that is not spike protected (such as a magnetic lock), use either a 1KV 1A diode or 100V, 4A bridge rectifier. Otherwise relay life may be shortened.

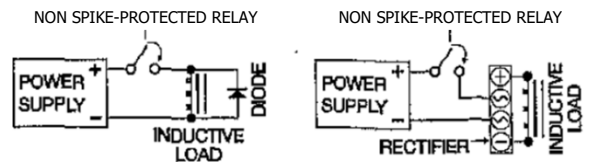

Most UL 1034 listed magnetic locks are already EMF spike-protected and therefore do NOT require a diode or bridge rectifier, and adding either could cause response delays. Check magnetic lock specifications.

Choose either Fail Safe or Fail Secure operation and wire to either EMF or Non EMF contacts as follows:

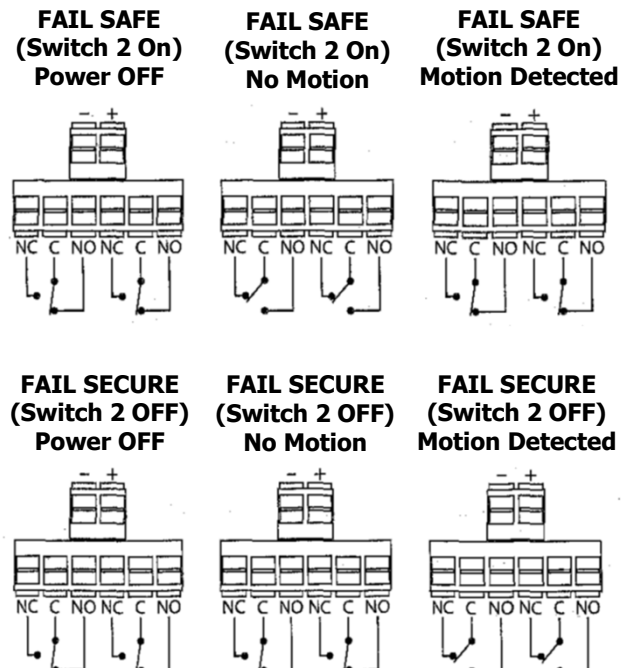

### DIP switch settings:

Selectable operational settings for the detector are programmed via the six (6) DIP switches on the circuit board and accessible with the "detector cover removed. Switches are in the on position when the raised part (shown as white below) is in the upward position toward the word "ON," and are in the off position when the raised part is in the downward position toward the switch number. Shown below are switches 1 -5 in the ON position and switch 6 in the OFF position:

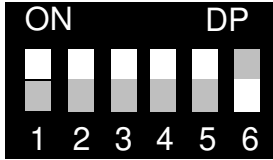

The following operational settings must be selected:

#### DIP SWITCH 1-Resettable/Non-resettable timer selection

DIP Switch 1 selects either relay reset at the end of latch time ("Resettable") or latch time extension upon additional motion ("Non-Resettable").

**Resettable-switch ON:** After motion initially activates the relay, each additional detection of motion causes the latch timer to restart. Only when there is no longer motion and the latch time is allowed to expire will the relay deactivate. This setting is suitable for bypassing a 24-hour contact.

**Non-resettable-switch OFF:** After motion initially activates the relay, the relay will deactivate when the latch time ends even if there is additional motion. This setting is suitable for use with access control systems.

**DIP SWITCH 2-Fail Safe/Fail Secure relay mode selection:** DIP Switch 2 selects either Fail Safe (doors unlocked) or Fail Secure (doors locked) operation in the event of a power failure. Setting selected must comply with all applicable regulations and be verified by local AHJ (Authority Having Jurisdiction).

**Fail Safe-switch ON:** In the event of a power failure, the relay causes the locking mechanism (such as door strike or magnetic lock) to unlock.

**Fail Secure-switch OFF:** In the event of a power failure, the relay causes the locking mechanism (such as door strike or magnetic lock) to remain locked. Use this setting only with AHJ approval as life safety can be affected. In addition, ensure there is no interference with functioning of any panic devices associated with the system PIR Motion Sensor is connected to.

**DIP SWITCH 3-LED Enable/LED Disable selection:** DIP Switch 3 selects either the LED to light upon detection of motion or remain off. It is recommended not to select disable prior to walk testing the detector as it can provide visual feedback of detector coverage pattern.

**LED Enable-switch ON:** LED lights upon detection of motion.

**LED Disable-switch OFF:** LED remains off.

#### DIP SWITCHES 4, 5 and 6-Latch Time selection

DIP Switch 4, 5 and 6 are used in combination to select the duration of the relay latch time after the relay is activated by motion detection. Use the following chart to select a latch time from 0.5 second to 64 seconds:

TIME (Seconds)	SWITCH 4	SWITCH 5	SWITCH 6
0.5 (Default)	OFF	OFF	OFF
1	OFF	OFF	ON
2	OFF	ON	OFF
4	OFF	ON	ON
8	ON	OFF	OFF
16	ON	OFF	ON
32	ON	ON	OFF
64	ON	ON	ON

### Installation:

Remove the cover of the detector by inserting a flat head screwdriver into the slot visible (at the extreme end opposite the end with the PIR lens) on the back of the detector and prying it off. Follow instructions for wiring and DIP switch settings.

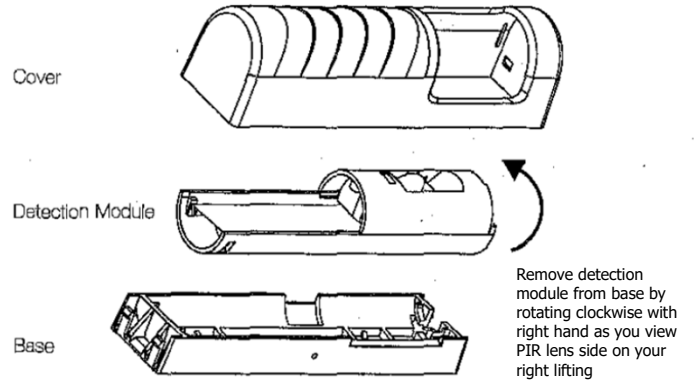

Route wires through the wiring entrances on the left side of the detector. For surface wiring, carefully cut out the breakaway notch provided on the cover at the same end as the wire entrances appear on the base.

The detector can be mounted from 7ft to 15 ft. (2. 1m to 4.6m) above the floor. Mounting height affects the detection pattern, generally expanding it as the height increases.

Mount the base to the mounting surface using mounting screws supplied. **The word "DOOR" on the base must be right side up (and arrows pointing down toward door) for correct mounting.**

Re-insert the detection module into the base (turning counter-clockwise, opposite of removal shown above). Aim the detector for coverage desired. Tighten detector module lock screw to prevent movement of the detector module and disruption of coverage pattern due to vibration, etc.

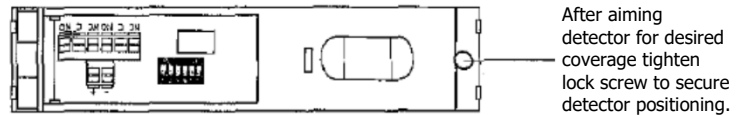

To mask the PIR detection pattern, insert masking wedges using small holes at top and bottom of PIR lens on outside surface of detector. Masking can reduce unintended activation by persons not intending egress.



After verifying detection coverage pattern by walk test, make sure all wiring and DIP switch settings are correct and that detection module aim is locked. Replace cover and press firmly to snap in place.

**Detection coverage pattern:**

The ideal installation of PIR Motion Sensor provides responsiveness to the motion of persons attempting to exit while minimizing unintended triggering of the detector. Persons moving at a normal pace toward the door(s) to exit should be able to push the door open without waiting for the door to unlock. Persons in areas not close to the door and not moving toward the door to exit should generally not cause the door to unlock by triggering the detector. Achieving the proper balance of ensuring responsiveness while minimizing unintended triggering is mostly a function of the following factors affecting the coverage pattern:

- o Choice of wall (including door frame) or ceiling mount
- o Mounting height
- o Aiming of the detector (vertical only)
- Masking of the PIR lens (see "Installation" on previous page)

In general, the further from the floor the detector is located, the larger the detection pattern becomes. The higher the detector is aimed, the further the pattern extends (when wall mounted) though detection range is limited to about 20 feet (about 6 meters) maximum. Aiming the detector lower to bring the coverage pattern closer to the door can help eliminate triggering from persons moving in the vicinity of the door without intending to exit. When selecting Non-resettable latch time (DIP switch 2 OFF), adjust latch time (DIP switches 4,5 and 6) to allow persons intending to exit to reach the door in time after triggering the detector.

The Fresnel lens of the PIR detector is segmented to provide six (6) dual detection zones. The body heat (IR energy) of a person moving through a zone triggers the detector. When wall mounted at a height of 7' with the detector aimed downward by 14" PIR Motion Sensor, produces approximately the following coverage pattern on the floor as seen from above:

Top view of coverage pattern on the floor at 7' wall mount height with -14° aim

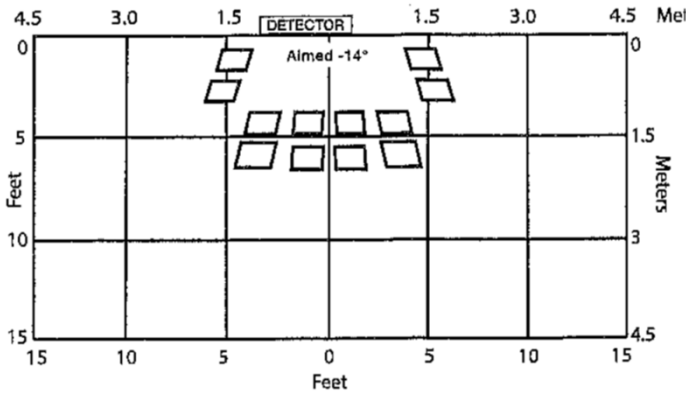

When wall mounted at a height of 15' with the detector aimed upward by 14" PIR Motion Sensor, produces approximately the following expanded coverage pattern on the floor as seen from above:

Top view of coverage pattern on the floor at 15' wall mount height with +14° aim

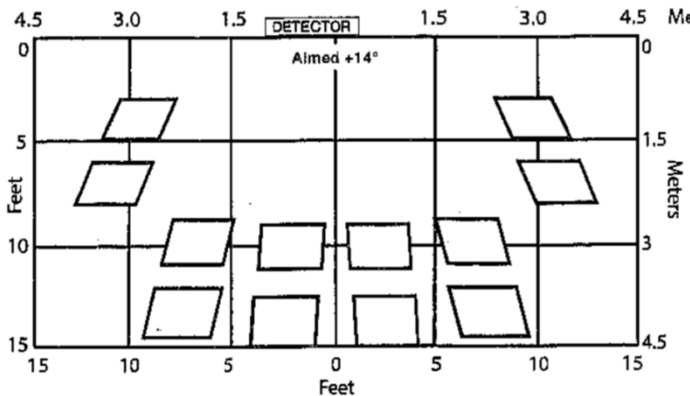

Aiming the detector lower brings coverage closer to the door, possibly reducing unintended triggering of the detector. When wall mounted at a height of 7' with the detector aimed downward by 14", PIR Motion Sensor, produces approximately the following coverage pattern on the floor as seen from above:

Top view of coverage pattern on the floor at 7' wall mount height with -14° aim

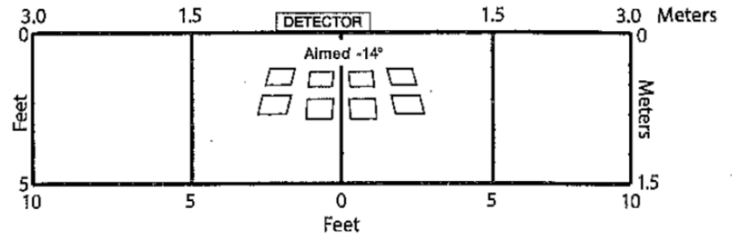

When wall mounted at a height of 15' with the detector aimed downward by 14", PIR Motion Sensor, produces approximately the following expanded coverage pattern on the floor as seen from above:

Top view of coverage pattern on the floor at 15' wall mount height with -14° aim

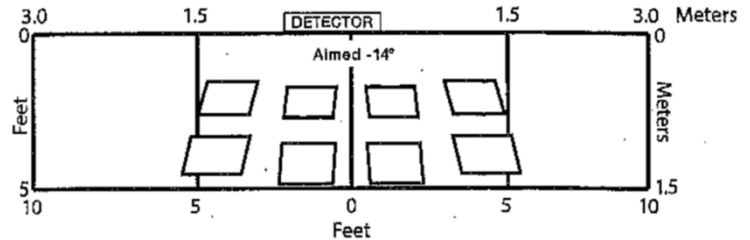

Viewed from the side, the coverage range is approximately as follows:

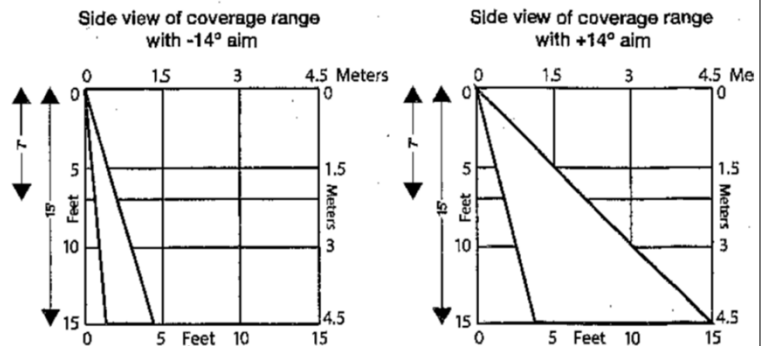

To provide responsive egress for double doors, mount one PIR Motion Sensor above the center of each door and wire the outputs so that detection of motion by either detector will unlock the doors. In most cases, masking the inside zones on both detectors will not affect responsiveness yet may reduce the possibility of triggering from insertion of an object between the two doors.

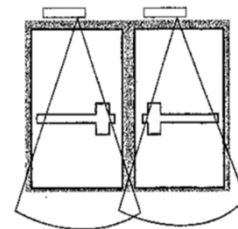

The gap between double doors without a center post may allow intruders to trigger the motion detector by inserting a hot or cold object into the detection pattern. An alternative mounting option should be chosen to avoid this possibility, such as ceiling mounting away from the door.

**Installation testing:**

**All wiring connections should be made and verified before any power is connected to the detector. All power, including standby battery if used, should be disconnected.**

**Do not replace detector cover before the following have been completed:**

- All wiring connections have been made and verified
- Detector has been properly mounted
- A walk test has been conducted to confirm coverage and proper functioning of the system

Apply power to the unit after determining all wiring connections have been properly made and that no hazards exist. The detector's green LED will initially flash on and off unless it has been disabled (DIP switch 3 set to OFF position). The LED should be enabled (DIP switch 3 set to ON position) to conduct a proper walk test and can be disabled afterward if required prior to replacing detector cover.

Allow the detector to stabilize for five (5) minutes.' Conduct a walk test by approaching the door from all angles that persons can normally be expected to approach from and verify responsiveness. Adjust the detector aim up or down as necessary to optimize the detection pattern. Also verify that traffic not intending to exit does not typically trigger the detector. If necessary, adjust the detector aim. Mask the PIR lens if necessary.

Be sure to tighten the lock screw for the detector aim after detection coverage has been finalized.

Ensure that latch duration allows enough time to reach the door after detection and adjust if necessary.

Verify Fail-Safe or Fail-Secure operation by temporarily disconnecting power to the unit and determining that door is unlocked (Fail-Safe) or locked (Fail-Secure). Reset DIP switch 2 if necessary and repeat test. Setting selected must comply with all applicable regulations and be verified by local AHJ (Authority Having Jurisdiction).

After confirming the detector is operating as required (including leaving LED enabled or disabling it following final walk test), replace the cover and perform one final walk test to ensure proper operation. The detector should be tested at least once a year to ensure proper operation of all functions.

**Important Note:**

PIR Motion Sensor is designed for installation by properly trained, experienced and qualified technicians only. It should be installed in compliance with all applicable local, regional and national electrical and safety codes.

**Performance Level**

**PIR Motion Sensor meets the following performance levels for Access Control (UL294 6th Edition):**

<u>Feature</u>	<u>Level</u>
Destructive Attack	I
Line Security	I
Endurance	IV
Standby Power	I

**Current Ratings:**

The following are the maximum current ratings for each input voltage:

<u>Input Voltage</u>	<u>Maximum Current</u>
12VDC	16mA
12VAC	18mA
24VDC	20mA
24VAC	22mA

**Install in accordance with National Electric Code (NEC 70) and the applicable National Fire Protection Association (NFPA) Installation Standards, local codes and the local Authority Having Jurisdiction (AHJ).**

**All Circuits Class 2**

**ACCESS CONTROL**



UL 294 LISTED  
ACCESS CONTROL SYSTEM UNITS  
Edition 6  
BP21043