

ROTON Model 780-110 is a Aluminum Continuous Geared Concealed Leaf Hinge. This hinge can be used for custom applications with thinner doors and /or non-standard frames. Clearance required between the hinge edge of the door and the frame rabbet is 5/16" (7.9mm) minimum. "HD" models have additional bearings and fasteners for heavy duty application.

Hinge Length

All ROTON Hinges are supplied approximately 1" shorter than the nominal door height to avoid threshold or carpet clearance problems. If the hinge must be trimmed shorter, first determine the correct hand of the door and orientation of the hinge. Then mark and trim from the *bottom* of the hinge only – do not cut from the top end.

NOM. DOOR HEIGHT	NOM. HINGE LENGTH	NUMBER OF FASTENERS (FRAME / DOOR)
6' 8"	79" (2006mm)	16 / 16
7' 0"	83" (2108mm)	18 / 18
7' 2"	85" (2159mm)	18 / 18
8' 0"	95" (2413mm)	20 / 20
10' 0"	119" (3022mm)	26 / 26

Total Clearance Between Door And Frame Width

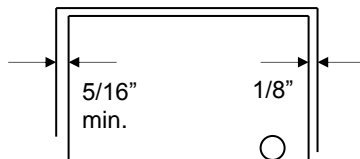

SINGLE DOOR - SQUARE EDGED

Hinge thickness	5/16" (7.9mm)
Allowance for frame irregularities	1/32" (0.8mm)
Latch side clearance (typical)	1/8" (3.2mm)
TOTAL*	15/32" (11.9mm)

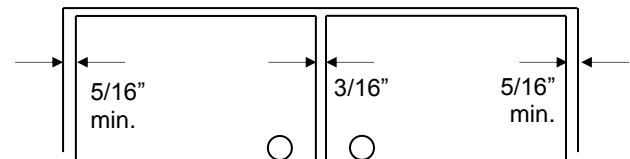

PAIR OF DOORS - SQUARE EDGED

First hinge thickness	5/16" (7.9mm)
First allowance for frame irregularities	1/32" (0.8mm)
Clearance between doors (typical)	3/16" (4.8mm)
Second hinge thickness	5/16" (7.9mm)
Second allowance for frame irregularities	1/32" (0.8mm)
TOTAL*	7/8" (22.2mm)

*For doors that are pre-beveled 1/8"-in-2" on the hinge edge, add 1/32" (0.8mm) per door to the TOTAL clearance shown.

General Fitting Procedure

- For new construction with metal doors/frames: To accommodate the 5/16" (7.9mm) hinge clearance required for these ROTON models, order the door undersized or the frame header oversized. See the clearance information above to attain the proper size. Mortar guards, either Styrofoam or wood, are recommended for frames to prevent grout from interfering with the installation of the hinge fasteners.
- For new site-hung wood doors: If necessary, scribe and cut from the *latch edge* of the door to leave sufficient hinge stile thickness for proper fastening. A minimum clearance of 5/16" (7.9mm) is required between the hinge edge of the door and the frame rabbet. See the clearance information above to attain the proper finished width of the door.
- For remodeling with existing wood or laminate doors: If necessary, scribe and cut from the hinge edge of the door and plane smooth. A minimum clearance of 5/16" (7.9mm) is required between the hinge edge of the door and the frame rabbet. See the clearance information above to attain the proper finished width of the door. Installation Procedure.

Installation Procedure

Frame Preparation

1. With the hinge open, place the hinge frame leaf against the frame rabbet making certain that the alignment rib is flush against the frame face along its entire length. Position the top of the hinge 1/16" (1/8" maximum) below the header. **Note: A 1/16" shim is recommended due to initial settling of the bearings.** (See Fig. 1)
2. Mark and center punch the screw hole locations. *Accurate location is important for proper installation.*
3. For metal frames 12 gage or less ($\leq .110"/2.8\text{mm}$), it is not necessary to pre-drill pilot holes if using the self-drilling screws provided. For metal frames thicker than 12 gage ($>.110"/2.8\text{mm}$), drill and tap all mounting holes for #12-24 threads prior to installing the screws. For wood frames, pre-drill pilot holes using a #18 (.170"/4.3mm) bit for optional #12 wood screws.
4. *Do not attach the hinge to the frame at this time.*

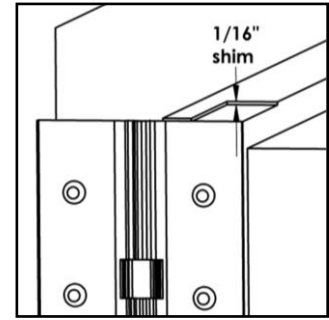

Fig. 1

Door Preparation

1. With the hinge open, place the hinge door leaf against the edge of the door making certain that the door alignment rib is flush against the door face along its entire length (See Fig. 2). Position the top of the hinge flush with the top of the door.
2. Mark and center punch the screw hole locations. *Accurate location is important for proper installation.*
3. For hollow metal doors 12 gage or less ($\leq .110"/2.8\text{mm}$), it is not necessary to pre-drill pilot holes if using the self-drilling screws provided. For metal doors thicker than 12 gage ($>.110"/2.8\text{mm}$), drill and tap all mounting holes for #12-24 threads prior to installing the screws. For wood doors, pre-drill pilot holes using a #18 (.170"/4.3mm) bit for optional #12 wood screws.
4. Attach the hinge to the door. For metal doors, use the #12 self-drilling screws provided (recommended driver speed 1,900-2,500 RPM). For wood doors, use optional #12 wood screws.

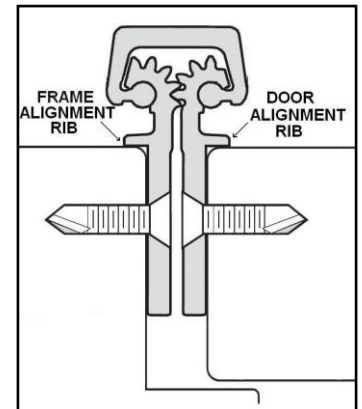

Fig. 2

Hanging the Door

1. Position the door (with hinge attached) at 90° to the frame. Attach the hinge to the frame rabbet (See Fig. 3). For metal frames, use the #12 self-drilling screws provided (recommended driver speed 1,900-2,500 RPM). For wood frames, use optional #12 wood screws.
2. Make a gentle trial swing. Carefully check the door for proper swing and clearance.

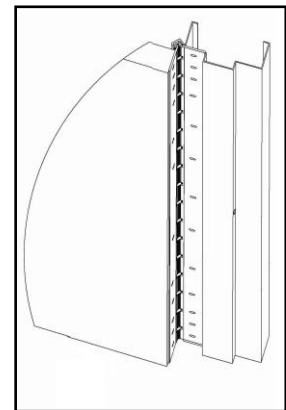
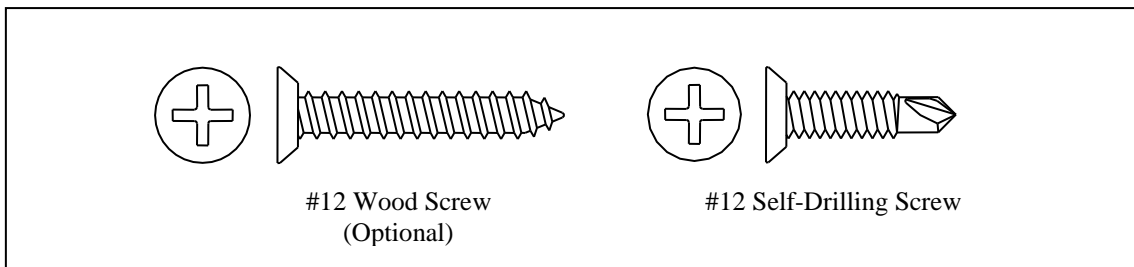

Fig. 3

Adjusting the Door

1. If lateral adjustment of the door is required due to excessive or uneven door/frame clearance, adjust by shimming where needed:
 - a) For minor adjustments, an effective shimming material is a 7/8" wide strip of cloth duct tape. Apply the tape in stepped layers underneath the frame leaf where needed to build up to the desired thickness.
 - b) To shift the entire door, a thin continuous aluminum strip may be used underneath the frame leaf.
2. Retighten all screws. Carefully check the door for proper swing and clearance.



FOLDING INSTRUCTIONS

1. **DO NOT USE THIS DRAWING FOR PRINTING** - USE INSTRUCTION FILE.
2. SINGLE SHEET (20# WEIGHT), DOUBLE-SIDED PRINTING ON 8-1/2" X 11"
3. FOLD SHEET AS SHOWN IN DETAIL "A", FOLDING INSTRUCTIONS

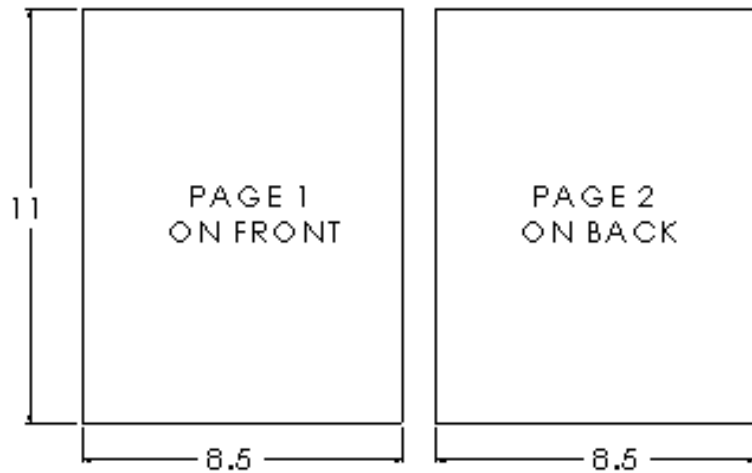

DETAIL "A" FOLDING INSTRUCTIONS

1. FOLD SHEET IN HALF ALONG WIDTH

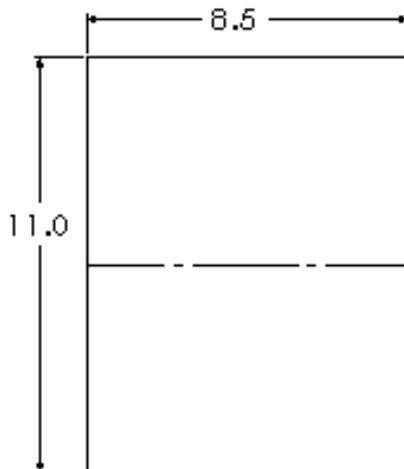

2. FOLD INTO THIRDS

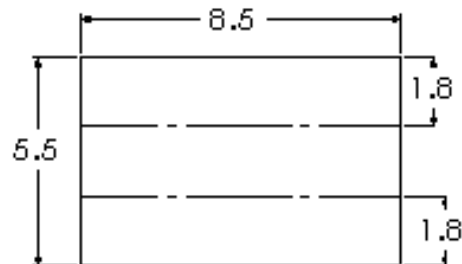

3. FOLDED SHEET WITH HAGER LOGO & REVISION DATE ON OUTSIDE

