



One Family. One Brand. One Vision.™

Hager Companies
139 Victor Street
St. Louis, MO 63104

800-325-9995 (main phone)
800-782-0149 (main fax)

www.hagerco.com
webmaster@hagerco.com



© 2016 Hager Companies
5-500-6500

Hager Euroline Catalog

It's been more than 166 years since Charles Hager first started working in a blacksmith shop. In that timespan, we've grown from forging wheel rims for Conestoga wagons to offering more than 6,000 door hardware products. Today, the products created by Hager Companies are found all over the world. And for good reason: they're built to last.

At Hager, we are committed to being your one source for full line door hardware. We stand alone as one family and one brand. We create products that make a difference in one community at a time, while being mindful of the one planet we all share.

Every product that Hager offers is backed by a legacy of quality, reputation, and excellence. For a complete collection of our products, visit us online at www.hagerco.com or request a complete catalog.





Most people in the North American door hardware industry are familiar with ANSI - American National Standards Institute, BHMA - Builders Hardware Manufacturers Association, along with UL - Underwriters Laboratories and Intertek. However these standards and fire codes, which are strictly enforced in the United States and Canada, are not customary in approximately 90% of the rest of the world.

European standards - EN and CE - are dominant in Europe, the Middle East and most of Asia. Any hardware products sold into areas that embrace these standards must meet their cycle and fire tests, which are completely different than those of ANSI and UL.

Hager Companies launched the Euroline in 2008 to provide a comprehensive product line that meets and exceeds EN and CE standards. It currently consists of a complete product portfolio including hinges, trim & auxiliary, door controls, exit devices, mortise locks, cylinders, levers, and accessories.

Since the product line has expanded and Hager Companies has been successful in marketing in Latin America, the Middle East and Asia. In addition, our Euroline products recently passed separate stringent fire tests in Mainland China.

As always, service is our number one priority and that is true for our global customers as well. We have representatives across the globe as well as distribution centers in Dubai, United Arab Emirates and Zhuhai, China.

Table of Contents

Locks	5	Exits.....	31
Lock Functions.....	6		
Lock Bodies	9	Patch Fittings	35
Lever Options - Locks	13		
Trim – Locks	21	Commercial Hinges	39
Cylinders	23		
		Trim & Auxiliary	41
Door Controls	25		
Surface Door Closers.....	26		
Surface Door Closers - Accessories	27		
Concealed Door Closers.....	28		
Floor Springs	29		

Locks



European locksets are sold in component form: lock body, lever set and cylinder. This allows end users to mix and match cylinders, levers and lock bodies from a vast array of different manufacturers. It also allows multiple mechanical and electronic keyways to be used interchangeably. This modular approach allows for greater flexibility on the jobsite. Consult the diagram and charts on the next three pages to see function options and the components required.



LOCK FUNCTIONS

Lock Components

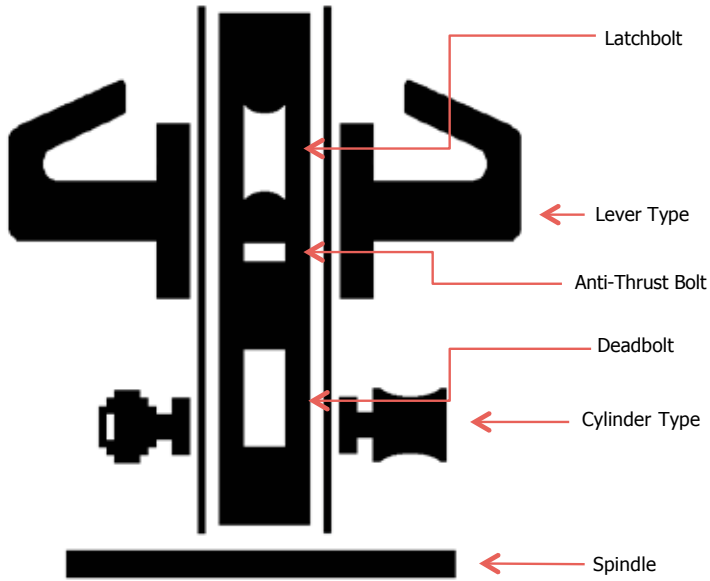



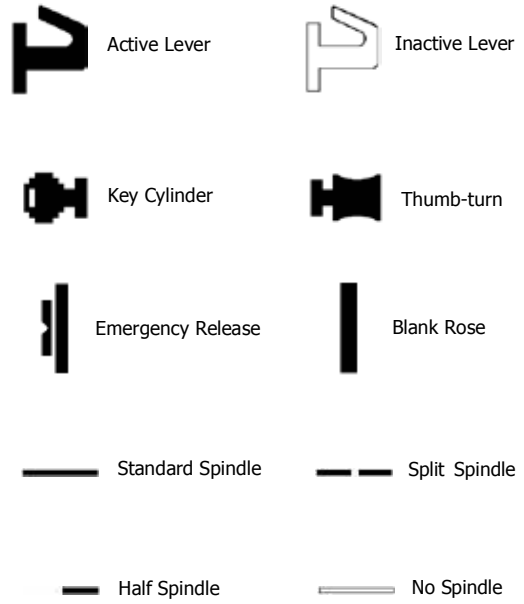





Symbol Key













LOCK FUNCTIONS

Picture	Function	Function Description	Required Parts
	Passage	Latchbolt operated by lever from either side at all times.	3800U-55L Leverset
	Bathroom Indicator	Latchbolt operated by lever from either side at all times. Deadbolt operated by thumbturn from inside and by emergency release with indicator from outside.	3800U-55B Leverset 2-669-0736
	Privacy	Latchbolt operated by lever from either side at all times. Deadbolt operated by thumbturn from inside and by emergency release from outside.	3800U-55S Leverset 3000R
	Classroom	Latchbolt operated by lever from either side. Deadbolt operated by key from outside. Operating inside lever retracts both latchbolt and deadbolt simultaneously.	3800U-55P Leverset Split Spindle* 3000H
	Storeroom	Latchbolt operated by key from outside or by operating inside lever. Outside lever never retracts latchbolt.	3800U-55M Leverset Half Spindle** 3000H
	Security Storeroom	Latchbolt operated by key from outside or by operating inside lever. Outside lever never retracts latch. Anti-thrust bolt.	3800U-55T Leverset Half Spindle** 3000H
	Exit	Latchbolt operated by lever from either side. Deadbolt operated by key from outside and by thumbturn from inside. Operating inside lever retracts both latchbolt and deadbolt simultaneously.	3800U-55P Leverset Split Spindle* 3000C
	Entrance	Latchbolt operated by lever from either side. Deadbolt operated by key from either side.	3800U-55S Leverset 3000D

* Use the split spindle in place of the spindle that comes with the leverset.

** Use the half spindle going into the inside lever in place of the spindle that comes with the leverset.

LOCK FUNCTIONS

Picture	Function	Function Description	Required Parts
	Bedroom	Latchbolt operated by lever from either side. Deadbolt operated by thumbturn from inside and emergency release from outside. Operating inside lever retracts both latchbolt and deadbolt simultaneously.	3800U-55P Leverset Split Spindle* 3000R
	Dormitory	Latchbolt operated by lever from either side. Deadbolt operated by key from outside and thumbturn from inside.	3800U-55S Leverset 3000C
	Institutional	Latchbolt operated by key from either side. Neither lever retracts latchbolt.	3800U-55M Leverset** 3000D
	Security Institutional	Latchbolt operated by key from either side. Neither lever retracts latchbolt. Anti-thrust bolt.	3800U-55T Leverset** 3000D
	Security Classroom	Latchbolt operated by lever from either side. Deadbolt operated by key from inside or outside. Operating inside lever retracts both latchbolt and deadbolt simultaneously.	3800U-55P Leverset Split Spindle* 3000D
	Double Deadbolt	Deadbolt operated by key from either side. No latchbolt.	3800U-55F 3000D
	Privacy Deadbolt	Deadbolt operated by key from outside and by thumbturn from inside. No latchbolt.	3800U-55F 3000C
	Single Deadbolt	Deadbolt operated by key from outside only. No latchbolt.	3800U-55F 3000H

* Use the split spindle in place of the spindle that comes with the leverset.

** Do not install the spindle that comes with the leverset.



LOCK BODIES



3000U-60H Series Sliding Door Mortise Lock

Warranty:	Three-year
Backset:	• 60 mm - 3800U-60H
Forend Length:	• 169.3 mm - 3800U-60H
Forend Width:	22 mm
Deadbolt Length:	• 18 mm - 3800U-60H
Strike Length:	104 mm
Strike Width:	22 mm
Material:	Steel
Finish:	US32D
Fasteners:	Four (4) 3.5 mm x 25 mm FPHWS
Includes:	Mortise lock, strike plate, and fixing screws
Notes:	3 mm forend round corners available upon request



3800U-55B Bathroom Mortise Lock

Warranty:	Three-year
Certifications:	<ul style="list-style-type: none"> • EN 12209: 2003 / EN1634 -1: 2000 (4-Hour Fire-Rated) • CE Classification 3X510F-BG20 • CertiFire CF 5283
Backset:	55 mm
Center to Center:	78 mm
Forend Length:	235 mm
Forend Width:	24 mm
Deadbolt Throw:	20 mm
Latchbolt Throw:	12.5 mm
Strike Length:	172 mm
Strike Width:	24 mm
Strike Width w/ Lip:	39 mm
Finish:	US32D
Fasteners:	Two (2) 4 mm x 25 mm FPHWS and three (3) 3.5 mm x 20 mm FPHWS
Includes:	Mortise lock body, strike plate, and fixing screws
Notes:	<ul style="list-style-type: none"> • Cylinders and levers sold separately • Field reversible, non-handed • 3 mm forend round corners available upon request • Non-CE certified version available



3800U-55D Deadlock Small Mortise Lock

Warranty:	Three-year
Backset:	55 mm
Forend Length:	150 mm
Forend Width:	24 mm
Deadbolt Throw:	22 mm
Strike Length:	90 mm
Strike Width:	24 mm
Material:	Steel
Finish:	US32D
Fasteners:	Four (4) 3.5 mm x 25 mm
Includes:	Mortise lock, strike plate, and fixing screws
Notes:	<ul style="list-style-type: none"> • Cylinders and levers sold separately • Field reversible, non-handed • 3 mm forend round corners available upon request

LOCK BODIES



3800U-55F **Deadbolt Mortise Lock**

Warranty:
Certifications:

Backset:
Forend Length:
Forend Width:
Deadbolt Throw:
Strike Length:
Strike Width:
Finish:
Fasteners:
Includes:
Notes:

Three-year
• EN12209: 2003 / EN1634-1: 2000 (4-Hour Fire-Rated)
• CE Classification 3X510F3BC00
• CertiFire CF 5283
55 mm
235 mm
24 mm
20 mm
90 mm
24 mm
US32D
Two (2) each 4 mm x 25 mm FPHWS and 3.5 mm x 25 mm FPHWS
Mortise lock body, strike plate, and fixing screws
• Cylinders and levers sold separately
• 3 mm forend round corners available upon request



3800U-55L **Latch Mortise Lock**

Warranty:
Backset:
Forend Length:
Forend Width:
Latchbolt Throw:
Strike Length:
Strike Width:
Strike Width w/ Lip:
Finish:
Fasteners:
Includes:
Notes:

Three-year
55 mm
235 mm
24 mm
12.5 mm
102 mm
24 mm
39 mm
US32D
Two (2) each 4 mm x 25 mm FPHWS and 3.5 mm x 19 mm FPHWS
Mortise lock body, strike plate, and fixing screws
• Levers sold separately
• Field reversible, non-handed
• 3 mm forend round corners available upon request



3800U-55M **Nightlatch Mortise Lock**

Warranty:
Certifications:

Backset:
Center to Center:
Forend Length:
Forend Width:
Latchbolt Throw:
Strike Length:
Strike Width:
Strike Width w/ Lip:
Finish:
Fasteners:
Includes:
Notes:

Three-year
• EN 12209: 2003 / EN 1634-1: 2000 (4-Hour Fire-Rated)
• CE Classification 3X510F-B020
• CertiFire CF 5283
55 mm
72 mm
235 mm
24 mm
12.5 mm
102 mm
24 mm
39 mm
US32D
Two (2) each 4 mm x 25 mm FPHWS and 3.5 mm x 19 mm FPHWS
Mortise lock body, strike plate, and fixing screws
• Cylinders and levers sold separately
• Field reversible, non-handed
• 3 mm forend round corners available upon request
• To be used with half spindle (2-669-0732), sold separately





LOCK BODIES



3800U-55P **Anti-Panic Mortise Lock**

Warranty:

Certifications:

Backset:

Center to Center:

Forend Length:

Forend Width:

Latchbolt Throw:

Deadbolt Throw:

Strike Length:

Strike Width:

Strike Width w/ Lip:

Finish:

Fasteners:

Includes:

Notes:

Three-year

- EN 179: 2008 / EN 1634-1: 2000 (4-Hour Fire-Rated)
- CE Classification 376B1342A B/D
- CertiFire CF 5283

55 mm

72 mm

235 mm

24 mm

12.5 mm

20 mm

172 mm

24 mm

39 mm

US32D

Two (2) 4 mm x 25 mm FPHWS and three (3) 3.5 mm x 19 mm FPHWS

Mortise lock body, strike plate, and fixing screws

- Deadbolt retracts with latch when inside lever is turned to allow emergency exit
- Cylinders and levers sold separately
- Field reversible, non-handed
- Must be used with 6802 lever for anti-panic compliance
- 3 mm forend round corners available upon request
- To be used with split spindles, 2-669-0733, sold separately

LOCK BODIES



3800U-55S **Sash Mortise Lock**

Warranty:

Certifications:

Backset:

Center to Center:

Forend Length:

Forend Width:

Deadbolt Length:

Latchbolt Length:

Strike Length:

Strike Width:

Strike Width with Lip:

Material:

Finish:

Includes:

Fasteners:

Notes:

Three-year

- EN 12209: 2003 / EN 1634-1: 2000 (4-Hour Fire-Rated)
- CE Classification 3X510F3BC20
- CertiFire CF 5283

55 mm

72 mm

235 mm

24 mm

20 mm

12.5 mm

172 mm

24 mm

39 mm

Steel

US32D

Mortise lock, strike plate, and fixing screws

Four (4) 3.5 mm x 25 mm FPHWS

- Cylinders and levers sold separately
- Field reversible, non-handed
- 3 mm forend round corners available upon request
- Non-CE certified version available



3800U-55T **Nightlatch w/ Anti-Thrust Bolt Mortise Lock**

Warranty:

Certifications:

Backset:

Center to Center:

Forend Length:

Forend Width:

Latchbolt Throw:

Strike Length:

Strike Width:

Strike Width w/ Lip:

Finish:

Fasteners:

Includes:

Notes:

Three-year

- EN 12209: 2003 / EN 1634-1: 2000 (4-Hour Fire-Rated)
- CE Classification 3X510F2BB20
- CertiFire CF 5283

55 mm

72 mm

235 mm

24 mm

12.5 mm

102 mm

24 mm

39 mm

US32D

Two (2) 4 mm x 25 mm FPHWS and two (2) 3.5 mm x 19 mm FPHWS

Mortise lock body, strike plate, and fixing screws

- Cylinders and levers sold separately
- Field reversible, non-handed
- 3 mm forend round corners available upon request
- To be used with half spindle (2-669-0732), sold separately





LEVER OPTIONS - LOCKS



6801 **Tube Lever**

Warranty:
Lever Rose:
Cylinder Rose:

Door Thickness:
Material:
Finish:
Includes:

Three-year
54 mm diameter
• 54 mm diameter
• 10 mm width
35 mm to 50 mm
Stainless steel
US32D
Two (2) levers, two (2) cylinder roses, and mounting hardware



6802 **Tube Lever**

Warranty:
Lever Rose:
Cylinder Rose:

Door Thickness:
Material:
Finish:
Includes:

Three-year
54 mm diameter
• 54 mm diameter
• 10 mm width
35 mm to 50 mm
Stainless steel
US32D
Two (2) levers, two (2) cylinder roses, and mounting hardware



6803 **Tube Lever**

Warranty:
Lever Rose:
Cylinder Rose:

Door Thickness:
Material:
Finish:
Includes:

Three-year
54 mm diameter
• 54 mm diameter
• 10 mm width
35 mm to 50 mm
Stainless steel
US32D
Two (2) levers, two (2) cylinder roses, and mounting hardware

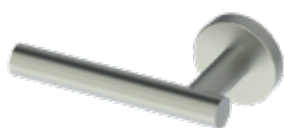

6805 **Tube Lever**

Warranty:
Lever Rose:
Cylinder Rose:

Door Thickness:
Material:
Finish:
Includes:

Three-year
54 mm diameter
• 54 mm diameter
• 10 mm width
35 mm to 50 mm
Stainless steel
US32D
Two (2) levers, two (2) cylinder roses, and mounting hardware

LEVER OPTIONS - LOCKS



6815

Solid Lever

Warranty:

Lever Rose:

Cylinder Rose:

Door Thickness:

Material:

Finish:

Includes:

Three-year

54 mm diameter

- 54 mm diameter

- 10 mm width

35 mm to 50 mm

Stainless steel

US32D

Two (2) levers, two (2) cylinder roses, and mounting hardware

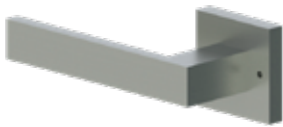

6823

Solid Lever

Warranty:

Lever Rose:

Cylinder Rose:

Door Thickness:

Material:

Finish:

Includes:

Notes:

Three-year

52 mm x 52 mm x 10 mm

52 mm x 52 mm x 10 mm

35 mm to 50 mm

Stainless steel

US32D

Two (2) levers, two (2) cylinder roses, and mounting hardware

Must specify handing

TRIM - LOCKS



2-669-0644 **Replacement Rose Kit**

Application: For use with Euroline deadlock mortise locks
Material: Stainless steel
Finish: US32D
Dimensions: 54 mm diameter
10 mm width
Fasteners: Two (2) M4 x 60 mm FPHMS with sex nuts plus
four (4) 4 mm x 22 mm FPHWS



2-669-0645/2-669-1363 **Lever Spindle Extension Kit**

Application: For use on doors 50 mm thick to 63.5 mm thick
Models: 2-669-0645; used with circular rose levers
2-669-1363; used with square rose levers
Material: Steel
Includes: One (1) extension shaft and four (4) M4 x 75 mm screws with sex nuts



2-669-0735 **Strike Dust Box**

Application: For use with Euroline mortise lock strike plates
Material: Plastic (white)
Includes: One (1) dust box



2-669-0736 **Bathroom Turn Indicator with Emergency Release**

Application: For use with 3800U-55B bathroom mortise lock
Rose Diameter: 52 mm
Rose Thickness: 4 mm
Knob Projection: 27 mm
Door Thickness: 51 mm maximum
Material: Stainless steel
Finish: US32D
Fasteners: Four (4) 3.5 mm x 25 mm





TRIM - LOCKS



2-669-0732

Half Spindle

Length:

Notes:

58 x 8 x 8 mm

- Used with 3800U-55M and 3800U-55T mortise night latches
- Hook at spindle head ensures secure fit when used with half lever sets



2-669-0733

Split Spindle

Length:

Notes:

52.5 x 8 x 8 mm each spindle

105 mm total length

- Used with 3800U-55P mortise anti-panic split follower locks
- Enables independent operation on inside and outside of doors





CYLINDERS

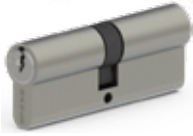

3000-D Series Double Cylinder

Warranty:	Three-year
Application:	For use with Euroline mortise locks
Function:	Key on both sides
Length:	<ul style="list-style-type: none"> • 60 mm - 3000-60D • 70 mm - 3000-70D • 75 mm - 3000-75D; H1 • 80 mm - 3000-80D
Material:	Brass
Finish:	US15
Cylinder:	<ul style="list-style-type: none"> • 5-pin (3000-60D) • 6-pin (3000-70D and 3000-80D) • 7-pin (3000-75D; H1)
Keyways:	Hager H1 or Schlage C
Keying:	<ul style="list-style-type: none"> • Keyed Different (KD) - standard (Schlage C keyway only) • Master Key (MK) - optional (H1 keyway only)
Keys:	Three (3) keys
Includes:	One (1) cylinder, three (3) nickel-plated steel keys, and one (1) fixing screw



3000-H Series Half Cylinder

Warranty:	Three-year
Application:	For use with Euroline mortise locks
Function:	Key one side, other side blank
Length:	<ul style="list-style-type: none"> • 40 mm - 3000-40H • 45 mm - 3000-45H • 50 mm - 3000-50H; H1
Material:	Brass
Finish:	US15
Cylinder:	<ul style="list-style-type: none"> • 5-pin (3000-40H) • 6-pin (3000-45H) • 7-pin (3000-50H; H1)
Keyways:	Hager H1 or Schlage C
Keying:	<ul style="list-style-type: none"> • Keyed Different (KD) - standard (Schlage C keyway only) • Master Key (MK) - optional (H1 keyway only)
Keys:	Three (3) keys
Includes:	One (1) cylinder, three (3) nickel-plated steel keys, and one (1) fixing screw

CYLINDERS

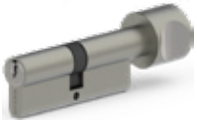

3000-C Series Thumbturn Cylinder

Warranty:	Three-year
Application:	For use with Euroline mortise locks
Function:	Key one side, thumbturn other side
Length:	<ul style="list-style-type: none"> • 60 mm - 3000-60C • 70 mm - 3000-70C • 75 mm - 3000-75C; H1 • 80 mm - 3000-80C
Material:	Brass
Finish:	US15
Cylinder:	<ul style="list-style-type: none"> • 5-pin (3000-60C) • 6-pin (3000-70C and 3000-80C) • 7-pin (3000-75C; H1)
Keyways:	Hager H1 or Schlage C
Keying:	<ul style="list-style-type: none"> • Keyed Different (KD) - standard (Schlage C keyway only) • Master Key (MK) - optional (H1 keyway only)
Keys:	Three (3) keys
Includes:	One (1) cylinder, three (3) nickel-plated steel keys, and one (1) fixing screw

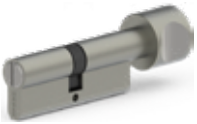

3000-R Series Thumbturn Cylinder with Emergency Release

Warranty:	Three-year
Application:	For use with Euroline mortise locks
Function:	Thumbturn one side, emergency release other side
Length:	<ul style="list-style-type: none"> • 60 mm - 3000-60R • 70 mm - 3000-70R • 80 mm - 3000-80R
Material:	Brass
Finish:	US15
Includes:	One (1) cylinder and one (1) fixing screw

Door Controls



Door control devices allow for precise regulation of both the opening and closing of commercial doors. Hager Companies' Euroline portfolio includes a wide range of door control products including universal surface mount closers, concealed in door models, and floor springs.



DOOR CONTROLS

SURFACE DOOR CLOSERS



5800R **Surface Door Closer**

Warranty:
Certifications:

Overall Dimensions:
Door Width:
Door Weight:
Maximum Opening:
Valves:

Adjustable Size:
Material:
Finish:
Options:

Five-year

- CertiFire CF 5390
- Tested to EN1154 (4:8:2/5:1:1:3)
- Certified for fire doors

 237 (l) x 55 (h) x 39 (projection) mm
 850 mm to 1250 mm
 45 kg to 110 kg
 180 degrees

- Adjustable latching and sweep speed valve
- Adjustable backcheck valve
- Adjustable delayed action valve

 2 to 5
 Aluminum
 Aluminum
 Hold open arm (2-659-0149)
 Sliding track arm (2-659-0087)
 Metal closer cover (2-659-0088)
 Parallel arm bracket (2-659-0097)



5800V **Surface Door Closer**

Warranty:
Certifications:

Overall Dimensions:
Door Width:
Door Weight:
Maximum Opening:
Valves:

Size:
Material:
Finish:
Options:

Five-year

- Tested to EN1154 (4:8:3:1:1:3)
- Certified for fire doors

 218 (l) x 59 (h) x 42 (projection) mm
 850 mm - 1100 mm
 45 kg - 80 kg
 180 degrees

- Adjustable latching and sweep speed valve
- Adjustable backcheck valve

 2 to 4 adjustable via mounting position
 Aluminum
 Aluminum
 Hold open arm (2-659-0149)
 Sliding track arm (2-659-0087)
 Parallel arm bracket (2-659-0097)



5800X **Surface Door Closer**

Warranty:
Certifications:

Overall Dimensions:
Door Width:
Door Weight:
Maximum Opening:
Valves:

Adjustable Size:
Material:
Finish:
Options:

Five-year

- CertiFire CF 5390
- Tested to EN1154 (4:8:3/6:1:1:3)
- Certified for fire doors

 275 (l) x 62 (h) x 45 (projection) mm
 950 mm - 1450 mm
 60 kg - 120 kg
 180 degrees

- Adjustable latching and sweep speed valve
- Adjustable backcheck valve

 3 to 6
 Aluminum
 Aluminum
 Hold open arm (2-659-0149)
 Sliding track arm (2-659-0087)
 Parallel arm bracket (2-659-0097)





DOOR CONTROLS

SURFACE DOOR CLOSERS - ACCESSORIES



2-659-0087

Slide Arm and Track Assembly

Warranty: Five-year
Material: Aluminum track, steel arm
Finish: Aluminum
Overall Dimensions: 19 (h) x 547 (w) 29 (d) mm
Notes: For use with 5800R, 5800X and 5800V



2-659-0088

Surface Door Closer Cover

Material: Stainless steel
Finish: US32D
Overall Dimensions: 73 (h) x 267 (w) x 38 (d) mm
Notes: **For use with 5800R only**



2-659-0097

Parallel Arm Bracket

Material: Steel
Finish: Aluminum
Notes:

- Can be used to convert regular or top jamb arm to parallel arm
- For use with 5800R, 5800X and 5800V



2-659-0149

Hold Open Arm for Surface Door Closer

Material: Steel
Finish: Aluminum
Notes:

- For use with 5800R, 5800X and 5800V
- Adjustable hold open angle

DOOR CONTROLS

CONCEALED DOOR CLOSERS



5800C

Concealed Door Closer

Warranty:	Five-year
Certifications:	Conforms to EN1154
Body Dimensions:	230 (l) x 32 (w) x 70 (h) mm
Track Dimensions:	460 (l) x 29 (w) x 19 (h) mm
Size:	3
Maximum Opening:	120 degrees
Door Width:	950 mm
Door Weight:	60 kg
Mechanism:	Rack and pinion
Material:	Aluminum
Finish:	Aluminum
Notes:	Track comes standard with hold open feature (can be removed to become non-hold open)



5800D

Concealed Door Closer

Warranty:	Five-year
Certifications:	<ul style="list-style-type: none"> • CertiFire CF 5392 • Tested to EN1154 (4:8:2/4:1:1:3) • Certified for fire doors (unless using hold open feature)
Body Dimensions:	210 (l) X 32 (w) X 53.5 (h) mm
Track Dimensions:	460 (l) x 29 (w) x 19 (h) mm
Door Width:	850 mm - 1100 mm
Door Weight:	40 kg - 80 kg
Adjustable Size:	2 to 4
Maximum Opening:	120 degrees
Mechanism:	Cam action
Material:	Aluminum
Finish:	Aluminum
Notes:	<ul style="list-style-type: none"> • Track comes standard with hold open feature (can be removed to become non-hold open) • Double acting

CE





DOOR CONTROLS

FLOOR SPRINGS

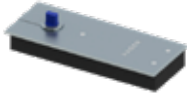

5800F

Floor Spring

Warranty:	Five-year
Certifications:	Tested to EN1154 (4:8:3:1:1:3)
Overall Dimensions:	306 (l) x 108 (w) x 40 (h) mm
Size:	3
Maximum Opening:	130 degrees
Door Width:	950 mm maximum
Door Weight:	105 kg
Material:	Cast iron
Finish:	US32D
Cover:	US32D stainless steel

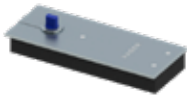

5815F

Floor Spring with 90 Degree Hold Open

Warranty:	Five-year
Certifications:	Conforms to EN1154
Overall Dimensions:	306 (l) x 108 (w) x 40 (h) mm
Size:	3
Maximum Opening:	130 degrees
Door Width:	950 mm maximum
Door Weight:	105 kg
Material:	Cast iron
Finish:	US32D
Cover:	US32D stainless steel
Notes:	Built in hold open



5800H

Floor Spring

Warranty:	Five-year
Certifications:	Conforms to EN1154 (4:8:3/6:1:1:3)
Overall Dimensions:	323 (l) x 94 (w) x 62 (h) mm
Adjustable Size:	3 to 6
Maximum Opening:	150 degrees
Door Width:	1450 mm maximum
Door Weight:	300 kg
Material:	Cast iron
Finish:	US32D
Cover:	US32D stainless steel



5815H

Heavy Duty Floor Spring with 90 Degree Hold Open

Warranty:	Five-year
Certifications:	Conforms to EN1154
Overall Dimensions:	323 (l) x 94 (w) x 62 (h) mm
Adjustable Size:	3 to 6
Maximum Opening:	150 degrees
Door Width:	1450 mm maximum
Door Weight:	300 kg
Material:	Cast iron
Finish:	US32D
Cover:	US32D stainless steel

Exit Devices



Exit devices are the most important life safety product in a building's security system. They are the item on a door that we all need to rely on to exit in either a panic or an emergency. Exit devices should not require any person to have prior knowledge of their function – you just push and go. Hager offers exit devices in rim and surface vertical rod versions in both stainless steel and silver painted finishes to suit the vast majority of door sizes and applications.



EXIT DEVICES



4200 Series Rim Rim Exit Device

Warranty:

Certifications:

Application:

Features:

Trim:

Functions:

Door Width:

Door Thickness:

Projections:

Fasteners:

Latchbolt:

Strikes:

Finishes:

Three-year

- Tested to EN1125 (3:7:6:B:1:4:2:2:B:A)
- Certified for fire doors (60m Wood Doors)
- For single doors
- The first opening leaf of double doors when using a double door strike
- Stainless steel construction
- Dead locking latch bolt standard
- Non-handed
- 42CE - William lever with cylinder escutcheon
- 42KE - Withnell lever with key in lever
- Cylinder escutcheon - key locks or unlocks lever
- 762 mm to 1220 mm for single doors
- 1524 mm to 2440 mm for double doors
- Up to 50 mm
- 63 mm
- Wood and machine screws
- Thru-bolts
- Stainless steel 15 mm throw with automatic dead-latching
- Stainless steel door strike supplied standard
- Stainless steel double door strike optional (2-649-5011)
- US32D, ALM
- Trim only available in US32D



4200 Series Surface Vertical Rod Surface Vertical Rod Mount Panic Exit Device

Warranty:

Certifications:

Application:

Features:

Trim:

Functions:

Door Width:

Door Height:

Door Thickness:

Projections:

Fasteners:

Latchbolt:

Strikes:

Finishes:

Three-year

- Tested to EN1125 (3:7:6:B:1:4:2:2:B:C)
- Certified for fire doors (60m Wood Doors)
- For single or double doors
- Stainless steel construction
- Non-handed
- 42CE - William lever with cylinder escutcheon
- 42KE - Withnell lever with key in lever
- Cylinder escutcheon - key locks or unlocks lever
- 762 mm to 1220 mm for single doors
- 1524 mm to 2440 mm for double doors
- 1524 mm to 2134
- Up to 50 mm
- 63 mm
- Wood and machine screws
- Thru-bolts (latches only)
- Top - Stainless steel 15 mm throw with automatic dead-latching
- Bottom - Stainless steel 15 mm throw, held retracted during door swing
- Stainless steel top and bottom strike supplied standard
- Stainless steel double door strike supplied standard
- US32D, ALM
- Trim only available in US32D



EXIT DEVICE TRIM



42CE

4200 Series Cylinder Escutcheon Trim

Warranty:	Three-year
Function:	Key locks or unlocks lever
Levers:	William lever
Projection:	84.1 mm
Escutcheon:	47 mm x 211 mm
Cylinders:	<ul style="list-style-type: none">• 3000-40 H half cylinder (sold separately)• 45 mm & 50 mm will work, but will not be flush (sold separately)
Door Thickness:	Up to 50 mm
Backset:	56 mm for Hager 4200 Exit Devices
Finish:	US32D
Notes:	Non-handed



42KE

4200 Series Key-in-Lever Trim

Warranty:	Three-year
Function:	Entrance by lever exit device trim (key locks or unlocks lever)
Levers:	Withnell lever
Projection:	55 mm
Standard Door Prep:	54 mm diameter (cross bore)
Rose Diameter:	76 mm
Keys:	Three (3) brass keys supplied per lock
Cylinders:	Brass 5-pin (Schlage C keyway standard)
Door Thickness:	Up to 50 mm
Backset:	56 mm for Hager Exit Devices
Finish:	US32D
Notes:	Non-handed

Patch Fittings



Patch fittings allow for the hanging and operation of glass doors in conjunction with floor springs and locking systems. Hager Companies provides a comprehensive range of patch fittings and pivot assemblies to work seamlessly with their floor springs and euro cylinders.



PATCH FITTINGS



651

Bottom Patch Fitting

Glass Thickness:

Material:

Maximum Door Weight:

Maximum Door Width:

Handing:

Finish:

Includes:

Installation:

Notes:

10-12 mm

- Cast aluminum base
- Stainless steel cover

80 kg

1100 mm

Suitable for left and right hand door (double acting)

US32

One (1) patch fitting and one (1) allen key

Clamp fixing, concealed with hexagonal socket screws

- Pivot post hole for use with all Hager 5800 floor closers
- Pivot laterally adjustable +/- 3 mm



652

Top Patch Fitting

Glass Thickness:

Material:

Maximum Door Weight:

Maximum Door Width:

Handing:

Finish:

Includes:

Installation:

Notes:

10-12 mm

- Cast aluminum base
- Stainless steel cover

80 kg

1100 mm

Suitable for left and right hand door (double acting)

US32

One (1) patch fitting and one (1) allen key

Clamp fixing, concealed with hexagonal socket screws

- Pivot post bearing for use with upper and corner over panel patch fitting
- Pivot laterally adjustable +/- 3 mm



653

Overpanel Patch Fitting

Glass Thickness:

Material:

Maximum Door Weight:

Maximum Door Width:

Handing:

Finish:

Includes:

Installation:

Notes:

10-12 mm

- Cast aluminum base
- Stainless steel cover

80 kg

1100 mm

Suitable for left and right hand door (double acting)

US32

One (1) patch fitting and one (1) allen key

Clamp fixing, concealed with hexagonal socket screws

- Pivot post for use with top patch fitting
- Pivot laterally adjustable +/- 3 mm



PATCH FITTINGS



654

Corner Overpanel Patch Fitting

Glass Thickness:	10-12 mm
Material:	<ul style="list-style-type: none"> • Cast aluminum base • Stainless steel cover
Maximum Door Weight:	80 kg
Maximum Door Width:	1100 mm
Handing:	Suitable for left and right hand door (double acting)
Finish:	US32
Includes:	One (1) patch fitting and one (1) allen key
Installation:	Clamp fixing, concealed with hexagonal socket screws
Notes:	<ul style="list-style-type: none"> • Pivot post for use with top patch fitting • Pivot laterally adjustable +/- 3 mm



655

Bottom Lock Patch Fitting

Glass Thickness:	10-12 mm
Material:	<ul style="list-style-type: none"> • Cast aluminum base • Stainless steel cover
Handing:	Suitable for left and right hand door (double acting)
Finish:	US32
Includes:	Patch fitting, allen key, floor strikes hardware, Schlage C cylinder and three (3) keys
Installation:	Clamp fixing, concealed with hexagonal socket screws



2-659-0150

Heavy Duty Top Pivot

Material:	Cast aluminum base
Finish:	US15 top pivot cover plate
Includes:	<ul style="list-style-type: none"> • One (1) frame pivot • One (1) stainless steel US15 frame pivot cover with mount screws • Mounting hardware screw bag
Installation:	Vertically adjustable pivot pin for easy door installation
Notes:	For use with 652 and non-glass frames

Commercial Hinges



Hager Companies has been the market leader in commercial hinges for over 166 years. That unrivaled experience has been channeled into a range of EN certified hinges to meet the exacting standards of international markets. The Hager Euroline hinge offering includes regular standard duty, rising, and falling models in multiple sizes.

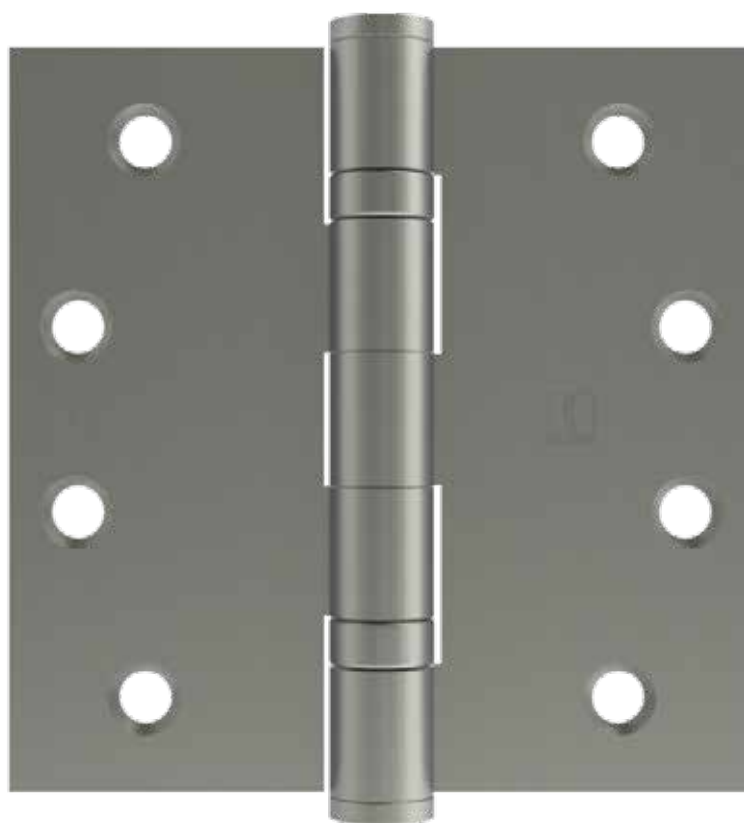

TWO KNUCKLE HINGES



7191
Rising Butt Hinge - Standard Weight - Full Mortise
 Stainless steel with stainless steel pin

- Three-year warranty
- Raises door upon opening
- Used to keep door in closed position
- Handed
- Available in US32D

Hinge Size	Gauge of Metal	Fasteners
102 mm x 76 mm	3 mm	5 mm x 32 mm FPHWS
102 mm x 102 mm	3 mm	5 mm x 32 mm FPHWS



7192
Falling Butt Hinge - Standard Weight - Full Mortise
 Stainless steel with stainless steel pin

- Three-year warranty
- Lowers door upon opening
- Used to keep door in open position
- Handed
- Available in US32D

Hinge Size	Gauge of Metal	Fasteners
102 mm x 76 mm	3 mm	5 mm x 32 mm FPHWS
102 mm x 102 mm	3 mm	5 mm x 32 mm FPHWS

FIVE KNUCKLE HINGES



BB6191
Ball Bearing - Standard Weight-Full Mortise
 Stainless steel with stainless steel pin

- Three-year warranty
- Certifications: EN1935 Grade 13 (Severe Duty for doors up to 120 kg), Corrosion resistance - Grade 4, and EN Certification No: 476114013
- CertiFire CF 5288
- For use on medium weight doors
- Available in US3, US5, US10B, US32D



Hinge Size	Gauge of Metal	Fasteners	
		Machine	Wood
89 mm x 89 mm	3 mm	M4.5 x 12 mm	4.5 mm x 25 mm FPHWS
102 mm x 76 mm	3 mm	M5 x 15 mm	5 mm x 32 mm FPHWS
102 mm x 89 mm	3 mm	M5 x 15 mm	5 mm x 32 mm FPHWS
102 mm x 102 mm	3 mm	M5 x 15 mm	5 mm x 32 mm FPHWS
127 mm x 89 mm	3 mm	M5 x 15 mm	5 mm x 32 mm FPHWS



INVISIBLE HINGES



1200 SERIES

Stainless steel with stainless steel pin

- Three-year warranty
- Available in US32D

Key to Dimensions Shown in Charts

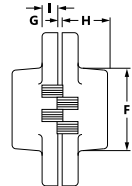
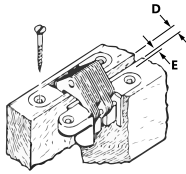
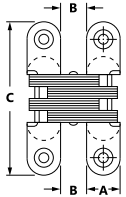

All hinges are shipped with the proper size wood screws, unless ordered without. Do not exceed "E" dimension.

Dimension	1212	1214	1216	1218
A	19mm	25.4mm	28.2mm	34.7mm
B	13.1mm	18.4mm	22.7mm	26.99mm
C	95mm	117.2mm	117.2mm	139.65mm
D	3.97mm	5.56mm	9.53mm	12.7mm
E	4.76mm	6.35mm	6.35mm	7.14mm
F	51.7mm	64.8mm	61.7mm	80.65mm
G	2.3mm	2.8mm	3.1mm	1.59mm
H	27.3mm	37mm	40.5mm	48.8mm
I	8.9mm	11.7mm	10mm	11.7mm

Trim & Auxiliary

To complement our extensive European offering, Hager Companies delivers a wide array of trim & auxiliary products for international markets. This includes door stops, bolts, dust proof strikes, coat hooks, and signage.



TRIM & AUXILIARY

DOOR STOPS



248E

Pedestal Door Stop

Base Diameter: 22 mm
 Height: 30.5 mm
 Materials: Stainless steel with rubber bumper
 Finish: US32D
 Fasteners: One (1) 5 mm x 30 mm FPHWS with anchor



248U

Pedestal Door Stop - Tall

Base Diameter: 28 mm
 Height: 37.5 mm
 Materials: Stainless steel with rubber bumper
 Finish: US32D
 Fasteners: One (1) 5 mm x 30 mm FPHWS with anchor



241E

Cast Flush Bolt

Base Diameter: 44 mm
 Height: 24.5 mm
 Materials: Stainless steel
 Finish: US32D
 Fasteners: One (1) 7 x 22 mm wood screw
 One (1) 6 x 25 mm plastic anchor

SURFACE BOLTS



277E

Surface Bolt

Bolt Length: 125 mm
 Bolt Height: 18 mm
 Bolt Depth: 6 mm
 Bolt Throw: 35 mm
 Base Width: 100 mm
 Knob Diameter: 25 mm
 Projection: 32 mm
 Material: Zinc
 Finish: US15
 Fasteners: Seven (7) 3.5 mm x 25 mm FPHMS



277T

Indicator Thumbturn Bolt

Bolt Length: 87 mm
 Bolt Height: 11.5 mm
 Bolt Width: 6 mm
 Bolt Throw: 19 mm
 Projection: 29 mm
 Material: Stainless steel
 Finish: US32D
 Fasteners: Eight (8) 3.5 mm x 25 mm FPHSMS
 Notes: 57 mm maximum door thickness



TRIM & AUXILIARY

FLUSH BOLTS & STRIKES



280E

Dust Proof Strike

Barrel Diameter: 19 mm
 Barrel/Plunger Diameter: 13.5 mm
 Depth: 36.5 mm
 Material: Stainless steel
 Finish: US32D



281E

Cast Flush Bolt

Length: 203 mm
 Width: 19.5 mm
 Depth: 38 mm
 Bolt Throw: 16 mm
 Material: Stainless steel
 Finish: US32D
 Fasteners: One (1) strike
 Two (2) #7 x 25 mm wood screws
 Two (2) #7 x 25 mm wood screws

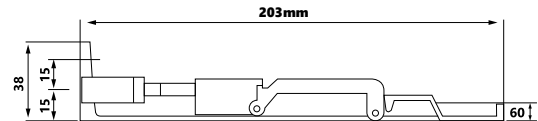

282E

Stamped Flush Bolt

Length: 304 mm
 Width: 25 mm
 Depth: 26.5 mm
 Bolt Throw: 20 mm
 Material: Stainless steel
 Finish: US32D
 Fasteners: One (1) strike
 Two (2) #7 x 19 mm wood screws
 Two (2) M4 x 12 mm machine screws

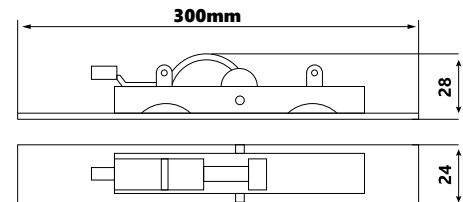

1420

Manual Flush Bolt

Length: 200 mm
 Width: 20.3 mm
 Depth: 16.5 mm
 Bolt Diameter: 9.9 mm
 Bolt Throw: 15.8 mm
 Material: Stainless steel
 Finish: US32D
 Strike Fasteners: Two (2) 3.5 mm x 19 mm FPHWS
 Flush Bolt Fasteners: Two (2) 3.5 mm x 25 mm FPHWS

TRIM & AUXILIARY

MISCELLANEOUS



299D

Concealed Door Chain

Materials: Strike - Stainless steel
Latch body - Plastic
Latch faceplate - Stainless steel

Door Thickness: 35 mm - 55 mm

Finish: US32D

Fasteners: Five (5) 3.5 mm x 25 mm FPHWS



1757

Door Viewer

Viewing Range: 145 Degrees

Material: Brass

Finish: US26D

Notes:

- PVC lens, with back cover
- For doors 35 mm - 55 mm thick, adjustable
- Requires 16 mm hole



298E

Door Selector

Material: Stainless steel

Finish: US32D

Length: 308 mm

Fasteners: Four (4) #10 x 35 mm wood screws
Four (4) M5 x 35 mm machine screws

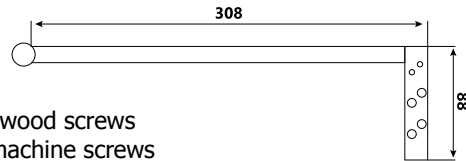

COAT HOOKS



6630

Double Coat Hook - Angled

Height: 72 mm

Upper Projection: 75.5 mm

Lower Projection: 30 mm

Material: Stainless steel

Finish: US32D

Fasteners: Two (2) 4 mm x 25 mm FPHWS



6640

Double Coat Hook - Straight

Height: 78 mm

Upper Projection: 72 mm

Lower Projection: 25 mm

Material: Stainless steel

Finish: US32D

Fasteners: Two (2) 4 mm x 25 mm FPHWS



TRIM & AUXILIARY

SIGNAGE



**371F
Female**

Size: 75 mm diameter
 Material: 1.6 mm thick 304 stainless steel
 Finish: US32D
 Fasteners: Two (2) 4 mm x 25 mm FPHWS



**371H
Handicap**

Size: 75 mm diameter
 Material: 1.6 mm thick 304 stainless steel
 Finish: US32D
 Fasteners: Two (2) 4 mm x 25 mm FPHWS



**371M
Male**

Size: 75 mm diameter
 Material: 1.6 mm thick 304 stainless steel
 Finish: US32D
 Fasteners: Two (2) 4 mm x 25 mm FPHWS



**371S
No Smoking**

Size: 75 mm diameter
 Material: 1.6 mm thick 304 stainless steel
 Finish: US32D
 Fasteners: Two (2) 4 mm x 25 mm FPHWS



**371U
Unisex**

Size: 75 mm
 Material: 1.6 mm thick 304 stainless steel
 Finish: US32D
 Fasteners: Two (2) 4 mm x 25 mm FPHWS

TRIM & AUXILIARY

Push/Pull Plates

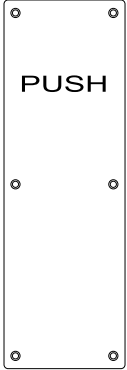

90E Push Plate

Warranty: 3 Year
 Width: 100 mm
 Length: 300 mm
 Thickness: 1.5 mm
 Material: Stainless Steel
 Finish: US32D
 Fasteners: Four (4) #7 x 19 mm wood screws

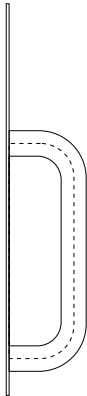
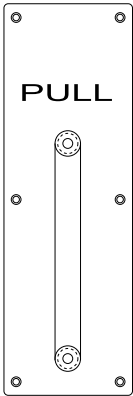

95E Pull Plate

Warranty: 3 Year
 Width: 100 mm
 Length: 300 mm
 Thickness: 1.5 mm
 Lever Projection: 60 mm
 Lever Diameter: 19 mm
 Material: Stainless Steel
 Finish: US32D
 Fasteners: Four (4) #7 x 19 mm wood screws



TRIM & AUXILIARY

