

Thresholds & Weatherstripping

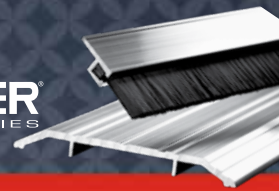

Hager Companies offers a complete line of thresholds & weatherstripping products for virtually any type of door application. What's more, each meets or exceeds ANSI-grade quality, durability, and performance levels. For enhanced levels of safety and security, we also offer intumescent products for positive pressure solutions, including edge sealing and smoke control systems. All of which make Hager threshold, weatherstripping, and door bottom products an excellent choice for standard or custom applications in schools, hospitals, office buildings, and more.

Table of Contents

General Information	2
---------------------------	---

Thresholds

Saddle	6
Thermal Barrier Saddle	8
Half Saddle	9
Elevator and Bumper Strips	10
Residential and Carpet.....	11
Bumpers and ADA Ramps.....	12
Floor Plate Assembly	13
Panic	14
Thermal Barrier Panic	15
Interlocking	16
Abrasive Cast Aluminum	17
Floor Closer	18
Cover Plate and Anchors	19
Vinyl Thresholds	19

Weatherstripping

Interlocking/Overhead Drip Guards	20
Press-On Gasketing	21
Door Bottoms	23
Automatic Door Bottoms	25
Door Bottom Sweeps.....	26
Adjustable Jamb Weatherstripping	29
Jamb Weatherstripping.....	30
Astragals/Meeting Stiles	35



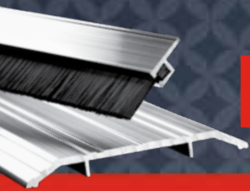

GENERAL INFORMATION

PRODUCT PRESENTATION

Dimensions on stainless steel extrusions may differ slightly than those detailed. Questions regarding any dimensions should be directed to Hager Companies Customer Service.

Drawings or illustrations used in the catalog are subject to change without notice. Questions on any dimensions should be obtained by contacting Hager Companies Customer Service.

FABRICATION OPTIONS

- Bevel one edge of threshold
- Rip one edge width of threshold
- L-notch both ends of threshold
- U-notch both ends of threshold
- Tack weld one line of threshold
- Pan for water return of threshold
- Sure Step Non-Slip Abrasive Coating – A rugged, durable coating that can be applied to all Hager Companies’ metal thresholds. Ideal for thresholds being used in wet, oily or corrosive environments.

MATERIALS & FINISHES

Metals

All aluminum extrusions are of alloy 6063-T5.

For stock finishes, refer to the code listed below each individual item throughout the catalog. Please inquire for the availability on nonstock finishes.

- MIL** - mill finish aluminum
- CAL** - cast aluminum
- GYP** - primed steel grey
- DBA** - dark bronze anodized aluminum
- SCA** - Hager Sure Step on aluminum
- 32D** - stainless steel (non-extruded)
- GLD** - gold anodized aluminum
- CLR** - clear anodized aluminum
- LBA** - light bronze anodized aluminum
- WHP** - white paint on aluminum
- USP** - prime coat

Gaskets

Gasketing is available in a wide variety of materials. Vinyl is an economical choice and remains flexible down to -40°F (-40°C). EPDM gasketing is supplied both as a solid (dense) and as a closed cell sponge with a tough outer skin. It remains flexible down to -50°F (-49°C). Silicone gasketing provides the best resistance to cold by remaining flexible down to -70°F (-57°C). Refer to the price book for a list of available replacement gaskets. Gasketing codes are listed below.

- B** - nylon brush
- N** - neoprene
- S** - silicone
- V** - vinyl
- W** - pile (thread may be removed to allow expansion)

ORDERING INFORMATION

When ordering, please specify by product number, length, quantity, finish and fasteners required. Thresholds & weatherstripping are fabricated in standard sizes with 1/2" (12.7 mm) extra on thresholds 48" (1219.2 mm) and under. Anodized thresholds are fabricated in standard sizes with 1/4" (6.35 mm) extra on thresholds 48" (1219.2 mm) and under. Thresholds over 48" (1219.2 mm) are supplied with 1" (25 mm) extra length for fitting. Anodized thresholds over 48" (1219.2 mm) are fabricated in standard sizes with 3/4" (19.05 mm) extra length for fitting. Exact lengths are available upon request (specify CTEL).

Example: 891S V 36 x 84 MIL

<u>Item #</u>	<u>Gasketing</u>	<u>Size</u>	<u>Finish</u>
516S	W-pile	36" (914 mm)	MIL - mill finish aluminum
599S	V-vinyl	48" (1219 mm)	DBA - dark bronze anodized aluminum
750S	S-silicone	36" (914 mm)	32D - matte stainless steel
870S	N-neoprene	36" x 84" (914 mm x 2133 mm)	CLR - clear anodized aluminum
882S	B-nylon Brush	48" x 96" (1219 mm x 2438 mm)	OOO - gasket only

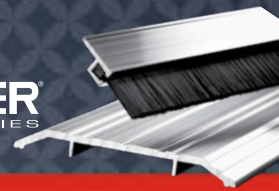

GENERAL INFORMATION

FASTENERS

Standard

All products are furnished with appropriate fasteners as listed, except where noted. Most thresholds are furnished with mounting holes and #10 x 1-1/2" flat head sheet metal screws. Most weatherstripping products are furnished with slotted holes and #6 x 5/8" pan head sheet metal screws.

Optional

Thresholds

- #10 wood screws and plastic anchors
- #10 wood screws and lead anchors
- #10 machine screws and lead anchors
- #10 stainless steel wood screws
- #10 stainless steel wood screws and plastic anchors
- #10 stainless steel wood and lead anchors
- 1/4-20 stainless steel machine screws and lead anchors
- 1/4-20 machine screws and lead anchors
- 1/4-20 x 2" flat head sleeve anchor
- #10 torx sheet metal screws
- #10-24 x 1-1/2" stainless steel torx machine screw with lead anchor
- #10-stainless steel spanner head wood screw with lead anchor
- Cast-on anchors (cast products only)
- Tap-con type (1/4" x 1-3/4")

Weatherstripping

- #6 x 5/8" pan-head stainless steel screws
- #6 x 5/8" self-drilling (TEK) screws (Steel-zinc plated)
- #6 x 5/8" pan-head torx sheet metal screws
- #6 x 5/8" stainless steel self-drilling (TEK) screws
- 1/4 - 20 x 1-1/4" sex bolts
- Two-way self-adhesive tape

GENERAL INSTALLATION INSTRUCTIONS FOR PRESS-ON PRODUCTS:

- Product returnable within first 6 months after purchase date
- Installation should take place after construction has been completed, and final cleaning has taken place
- The frame should be cleaned; isopropyl alcohol is recommended
- Not recommended for unsealed or porous applications
- Do not store these products in extreme heat/cold or for prolonged periods of time

CERTIFICATIONS



Handicap Accessibility

Products denoted by this symbol are designed for applications where handicap accessibility is specified. These products are no greater than 1/2" (12.7 mm) in height and have no more than 1/4" (6.3 mm) vertical rise or with slope proportions no greater than 1:2 slope. Offset floor conditions greater than 1/2" (12.7 mm) require a 1:12 slope.



Air Infiltration

Products denoted by this symbol have been tested with air/smoke infiltration, all within the (0.500 cfm/sq. ft. for double doors and .300 cfm for single doors) maximum allowable leakage at a pressure of a 25 mph wind (1.56 psf). The tests were conducted in accordance with ASTM test procedures and meet ASTM: E283.



Sound Tested

Products denoted by this symbol have been sound tested and received the appropriate STC rating. The tests were conducted in accordance with ASTM test procedures and meet ASTM: E90 & ASTM: E413.

STC Rating Static Door	STC Rating Operable Door	Perimeter Seal	Door Bottom	Corner Pad	Threshold
49	41	737 & 866S	743S	709	417S
49	37	738 & 737	743S	709	417S
44	40	726	743S		520S
42	40	738 & 737	774S	709	417S
42	40	737 & 866S	774S	709	417S
41	39	726(2)	743S		520S
36	35	738 & 737	774S	709	417S
36	35	726 & 736	774S	709	417S



BHMA Certified

BHMA Certification Program was developed as a means for manufacturers of builders hardware to indicate compliance with American National Standards sponsored by BHMA. Participating manufacturers certify compliance with the standards based on a continuing program of passing the prescribed tests.

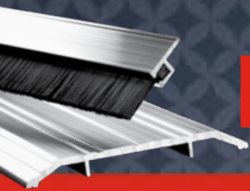

Underwriter’s Laboratories

Products denoted by this symbol are classified and labeled by Underwriter’s Laboratories, Inc.® as gasket material for use on listed steel frames and/or classified swinging type fire doors of the hollow metal or steel covered composite type rated up to 3 hours, or wood core fire doors rated up to 1-1/2 hours. Test results show these products do not adversely affect the fire resistance of the door or frame according to its UL rating. All products are regularly checked under a labeling and listing service. The clearance between the door and the frame and between the meeting edges of doors swinging in pairs shall be 1/8” ± 1/16” (3.18 mm ± 1.59 mm) for steel doors and shall not exceed 1/8” (3.2 mm) for wood doors.

- UL 10C (Positive Pressure) complies with IBC, NFPA 80 and NFPA 252 for hollow metal fire doors rated up to 3 hours and wood fire doors rated up to 90 minutes.
- UL 10B complies with NFPA 80 and NFPA 252 for hollow metal fire doors rated up to 3 hours and wood fire doors rated up to 90 minutes.

Notes: Ratings on some items may vary and are noted on the individual products. For a more complete look at classifications on individual products, please visit www.ul.com/database and reference R13647.

THE INTERNATIONAL BUILDING CODE (IBC)

The International Building Code (IBC) requires swinging fire doors to be tested in accordance with ANSI/UL 10C or NFPA 252, with the neutral pressure level established at 40 inches or less above the sill. This causes “positive pressure” forces against the door assembly above 40 inches.

The result is hot gases and smoke leak out between the door and frame above this level, posing a serious threat to life-safety; and on wood doors rapidly deteriorating the integrity of the door edges, requiring either a built-in or supplemental “edge sealing system” to pass the test.

Fire door assemblies in corridors and smoke barrier walls are required to be smoke and draft control assemblies tested in accordance with UL1784 allowing a maximum air leakage of 3 cubic feet per minute per square foot of door opening at ambient temperature (75°F) and elevated temperature (400°F). These assemblies require the letter “S” on the fire rating label of the door indicating compliance “when listed or labeled gasketing is also installed.”



Fire doors are classified based upon their construction and edge sealing system requirements. Fire-rated gasketing is classified as follows:

- Category G** - Edge-sealing system
- Category H** - Smoke and draft control gasketing
- Category J** - Gaskets other than category G or H

Fire Test - Category G

Gaskets that are edge-sealing systems. Category “G” - edge-sealing systems are for use with fire doors requiring an edge seal to meet positive pressure code requirements. These systems are surface-applied to either the perimeter of the door frame or meeting edges of door pairs. Category “G” gaskets are usually intumescent material; this material will swell many times its original size during a fire and help contain the spread of fire by sealing the edges of the door.

Fire Test - Category J

Products that are positive pressure tested to determine that they do not contribute to flaming during a fire; they do not provide an edge-sealing system. Examples are gaskets used for sound, draft control or automatic door bottoms.

Smoke and Draft Control Test - Category H

This is a separate second test that does not involve fire. All gaskets being tested for smoke must initially be fire tested under the requirements of UL 10C and receive a category “G” or “J” rating before being smoke tested.

Below are some key phrases that indicate positive pressure requirements:

- IBC 2003 (and later) - International Building Code
- UL 10-C - Positive Pressure Fire Test
- ASTM E-2074-00 - Fire Test of Door Assemblies
- Shall meet positive pressure requirements
- Intumescent seals - imply positive pressure

The www.iccsafe.org web site of the International Code Council (ICC) has a map of code adoption by state. This site is frequently updated and by clicking on a state, you can see what codes they have adopted.

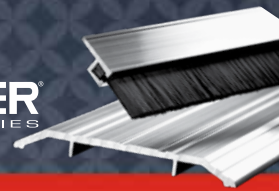

GENERAL INFORMATION

New and existing fire doors are classified/labeled by one of the following designation systems:

-  Hourly rating designation
  Alphabetical letter designation
  A combination of both

Common Applications for Hager Positive Pressure Edge Sealing & Smoke Seal Systems



Wall Rating	Door and Frame Rating	Door Application and Use	Door Types		Fire Doors Edge Sealing System	Smoke Doors "S" Label Smoke Seal	Fire & Smoke Doors Combination Seal
4 Hr.	3 Hour (A Label) 180 Minute	Openings in fire walls and walls that divide a single building into fire areas	Hollow Metal Hollow Metal	Pairs Singles	— —	721, 726, 736, 737 721, 726, 736, 737	— —



2 Hr.	1 1/2 Hour (B Label) 90 minute	Openings to stairwells and elevator shafts; vertical communication or egress through a building, including 2-hr. rated partitions providing horizontal fire separations	Wood Composite	Pairs	724, 729	721, 726, 736, 737	719, 720, 722, 734
			Hollow Metal	Pairs	—	721, 726, 736, 737	—
			Wood Composite	Singles	724, 729	721, 726, 736, 737	719, 720, 722, 734
			Hollow Metal	Singles	—	721, 726, 736, 737	—



2 Hr.	1 1/2 Hour (D Label) 90 minute	Opening where there is a chance of severe fire exposure from the exterior of the building	Hollow Metal	Pairs	—	721, 726, 736, 737	—
			Hollow Metal	Singles	—	721, 726, 736, 737	—



1 Hr.	*1 Hour (B Label) 60 Minutes	Doors that divide occupancies in a building (building less than 4 stories tall)	Wood	Pairs	724, 729	721, 726, 736, 737	719, 720, 722, 734
			Wood	Singles	724, 729	721, 726, 736, 737	719, 720, 722, 734

*Currently rating only applies to wood doors.



1 Hr.	3/4 Hour (E Label) 45 Minute	Opening in an exterior wall with the potential to be exposed to moderate to light fire from the outside of the building	Hollow Metal	Pairs	—	721, 726, 736, 737	—
			Hollow Metal	Singles	—	721, 726, 736, 737	—



1 Hr.	3/4 Hour (C Label) 45 Minute	Openings in walls or partitions between rooms and corridors	Wood Composite	Pairs	724, 729	721, 726, 736, 737	719, 720, 722, 734
			Wood Composite	Singles	724, 729	721, 726, 736, 737	719, 720, 722, 734



1 Hr.	*1/3 Hour 20 Minute	Openings in corridors where smoke and draft control is required *Does not have letter designation	Wood/Particle Core	Pairs	724, 729	721, 726, 736, 737	719, 720, 722, 734
			Wood/Particle Core	Singles	724, 729	721, 726, 736, 737	719, 720, 722, 734

*All of the labels listed above have the capability of being both fire and smoke barrier openings. However, not all openings require a smoke label. Openings requiring smoke labels are detailed either by the fire authority having jurisdiction, local code, NFPA 101 or NFPA 5000.

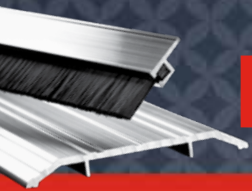

THRESHOLDS - SADDLE

To effectively seal out the elements, use in conjunction with a door bottom, sweep, shoe, or bumper strip.

Fasteners: #10 x 1-1/2" sheet metal screws, other screw types and anchors available upon request

Options: Available with Sure Step Non-Slip Abrasive Coating

- Notes:
- MIL finish thresholds are supplied with zinc plated screws
 - Color anodized thresholds are supplied with screws plated to match
 - Stainless steel thresholds are supplied with stainless steel screws

401S

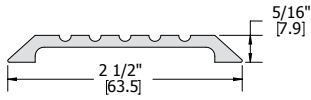

Finishes: MIL, DBA, GLD

Certifications:

402S

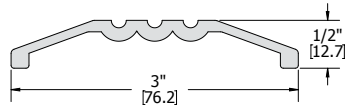

Finishes: MIL, DBA, GLD

Certifications:

403S

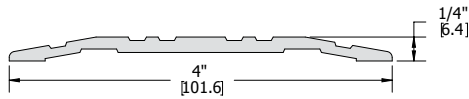

Finishes: MIL, DBA, GLD

Certifications:

404S

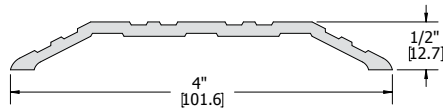

Finishes: MIL, DBA, GLD

Certifications:

410S

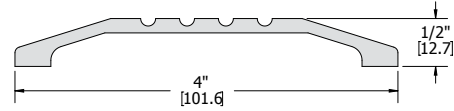

Finishes: MIL, DBA, GLD

Certifications:

412S

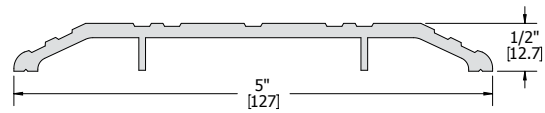

Finishes: MIL, DBA, GLD

Certifications:

413S

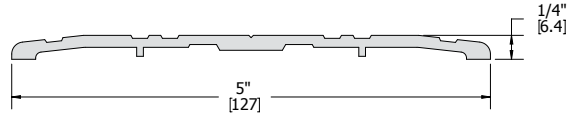

Finishes: MIL, DBA, GLD, US32D

Certifications:

415S

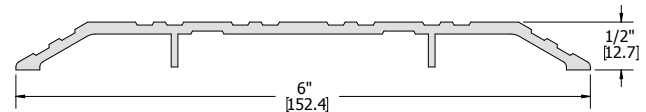

Finishes: MIL, DBA, GLD

Certifications:



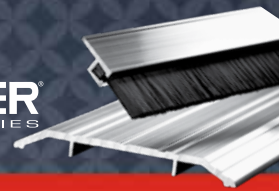

THRESHOLDS - SADDLE

416S

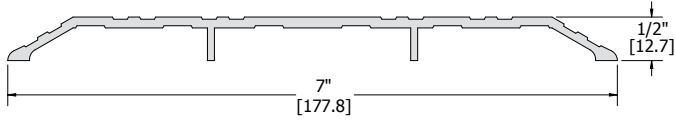

Finishes:

MIL, DBA, GLD

Certifications:



428S

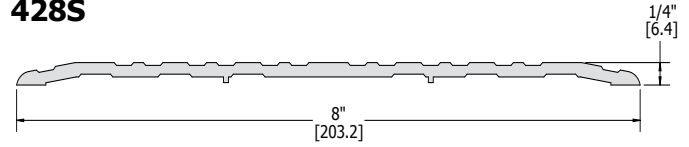

Finishes:

MIL, DBA, GLD

Certifications:



417S

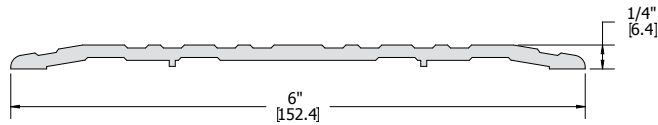

Finishes:

MIL, DBA, GLD

Certifications:



430S

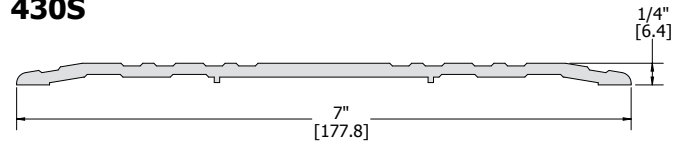

Finishes:

MIL, DBA, GLD

Certifications:



418S

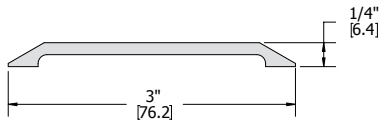

Finishes:

MIL, DBA, GLD

Certifications:



436S

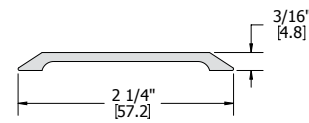

Finishes:

MIL, DBA

Certifications:



426S

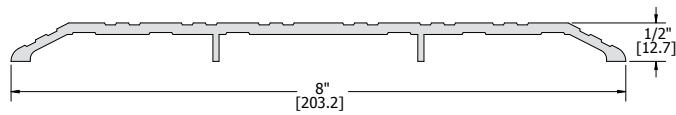

Finishes:

MIL, DBA, GLD

Certifications:



448S

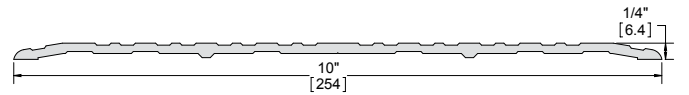

Finishes:

MIL, DBA

Certifications:



427S

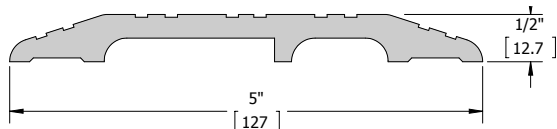

Finishes:

MIL, DBA

Certifications:



492S

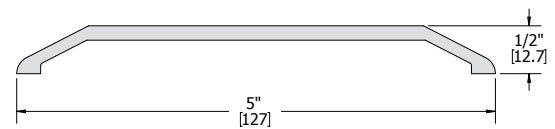

Finishes:

MIL, DBA, GLD

Certifications:



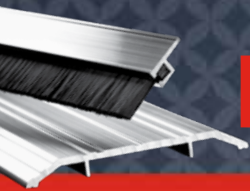

THRESHOLDS - THERMAL BARRIER SADDLE

High strength thermal barrier is permanently bonded in place to block the transfer of heat or cold. To provide a seal, use in conjunction with a door bottom, sweep, shoe or bumper strip.

Fasteners: #10 x 1-1/2" sheet metal screws, other screw types and anchors available upon request

Options: Available with Sure Step non-slip abrasive coating

Notes:

- MIL finish thresholds are supplied with zinc plated screws
- Color anodized thresholds are supplied with screws plated to match

420S

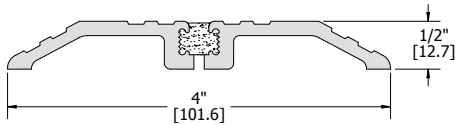

Finishes: MIL, DBA, GLD

Certifications:



424S

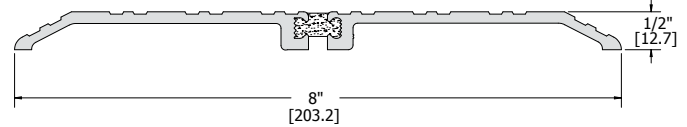

Finishes: MIL, DBA, GLD

Certifications:



451S

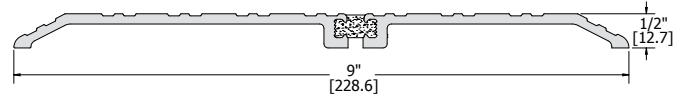

Finishes: MIL, DBA, GLD

Certifications:



421S

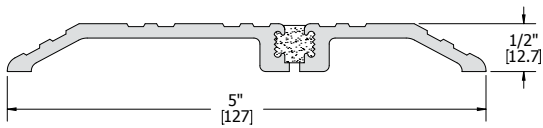

Finishes: MIL, DBA, GLD

Certifications:



452S

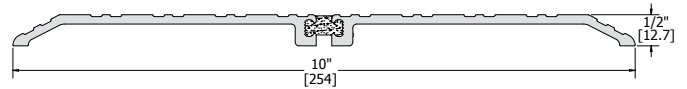

Finishes: MIL, DBA, GLD

Certifications:



422S

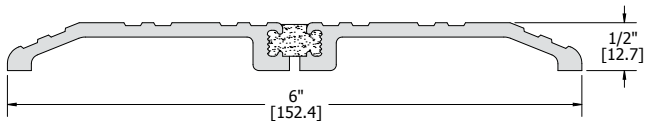

Finishes: MIL, DBA, GLD

Certifications:



423S

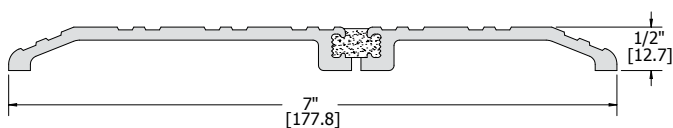

Finishes: MIL, DBA, GLD

Certifications:



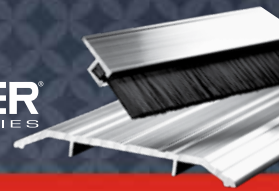

THRESHOLDS - HALF SADDLE

Fasteners: #10 x 1-1/2" sheet metal screws, other screw types and anchors available upon request

Options: Available with Sure Step non-slip abrasive coating

Notes:

- MIL finish thresholds are supplied with zinc plated screws
- Color anodized thresholds are supplied with screws plated to match

406S

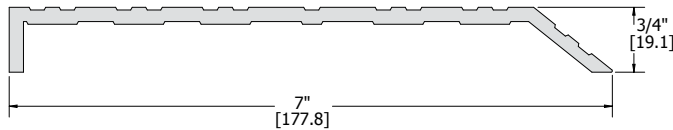

Finishes: MIL, DBA, GLD

Certifications: 

407S

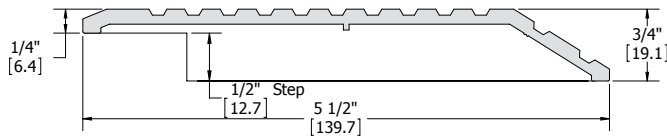



Finishes: MIL, DBA, GLD

Certifications: 

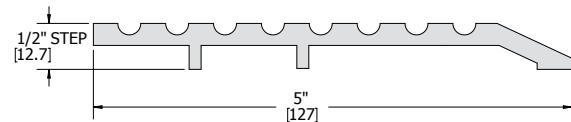
431S





Finishes: MIL, DBA, GLD

Certifications:   

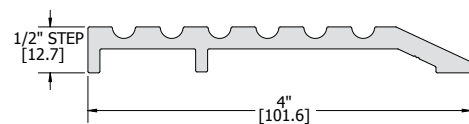
432S





Finishes: MIL, DBA, GLD

Certifications:   

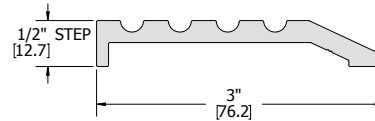
433S





Finishes: MIL, DBA, GLD

Certifications:   

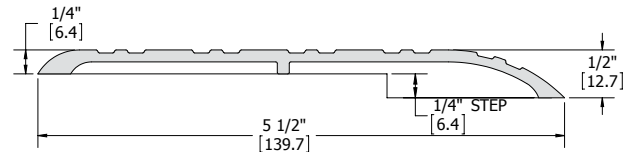
438S



Finishes: MIL, DBA

Certifications:   

572S

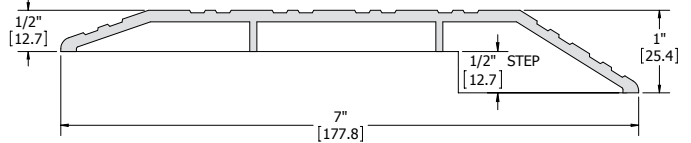

Finishes: MIL, DBA, GLD

Certifications: 

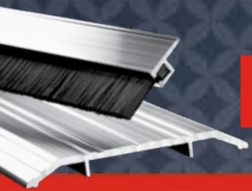

THRESHOLDS - ELEVATOR AND BUMPER STRIPS

Use in conjunction with a threshold

Fasteners: #10 - 24 x 5/8" flat head self-tapping screws to attach bumper strip directly to an existing threshold

481S

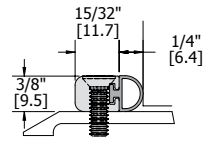

Finishes: MIL, DBA, GLD
 Insert: V, N, S, W
 Certifications:



484S

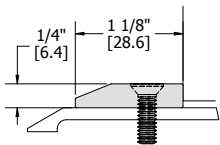

Finishes: MIL, DBA, GLD
 Certifications:



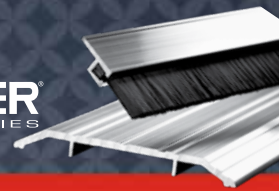

THRESHOLDS - RESIDENTIAL

All thresholds appearing in this column are available with Sure Step Non-Slip Abrasive Coating.

408S

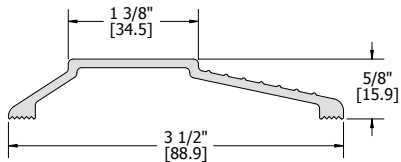

Finishes: MIL, DBA, GLD
 Certifications: 

419S

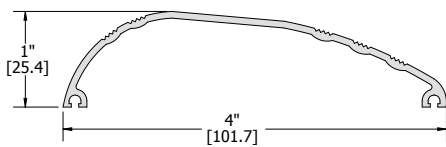

Finishes: MIL, DBA, GLD
 Certifications: 

THRESHOLDS - CARPET

Fasteners: #10 x 1-1/2" sheet metal screws, other screw types and anchors available upon request
 Options: Available with Sure Step non-slip abrasive coating
 Notes:

- MIL finish thresholds are supplied with zinc plated screws
- Color anodized thresholds are supplied with screws plated to match

503S

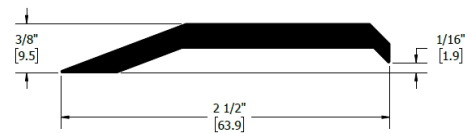

Finishes: MIL, DBA, GLD
 Certifications: 

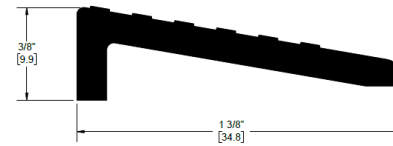

504S



Finishes: MIL, DBA, GLD
 Certifications: 

505S



Finishes: MIL, DBA, GLD
 Certifications:  

506S

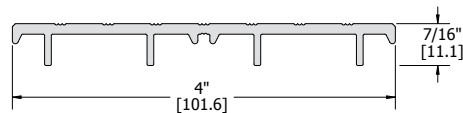

Finishes: MIL, DBA, GLD
 Certifications:  

508S

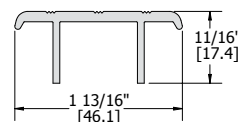

Finishes: MIL, DBA, GLD
 Certifications: 

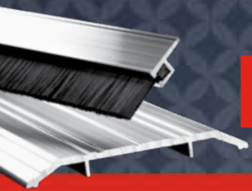

THRESHOLDS - BUMPER

For use with outswinging doors to seal out the elements

Fasteners: #10 x 1-1/2" sheet metal screws, other screw types and anchors available upon request

Options: Available with Sure Step non-slip abrasive coating

Notes:

- MIL finish thresholds are supplied with zinc plated screws
- Color anodized thresholds are supplied with screws plated to match

434S

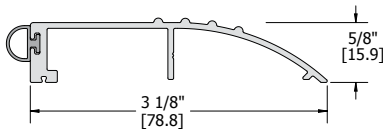

Finishes: MIL, DBA, GLD
 Insert: V, N, S, W
 Certifications:

435S

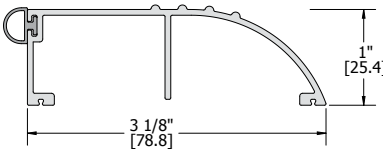

Finishes: MIL, DBA, GLD
 Insert: V, N, S, W
 Certifications:

477S

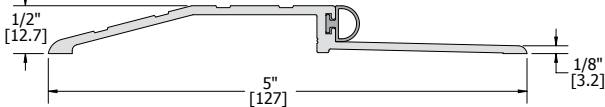

Finishes: MIL, DBA, GLD
 Insert: V, N, S, W
 Certifications:

478S

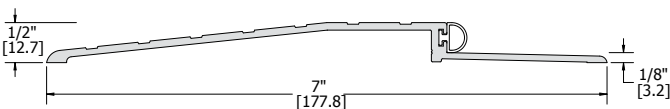

Finishes: MIL, DBA, GLD
 Insert: V, N, S, W
 Certifications:

THRESHOLDS - ADA RAMP

Ramp threshold that provides a 1:12 slope to meet the requirements of the Americans With Disabilities Act

Order: To create a ramp that is a combination of the 442S and 443S, order 444S

Fasteners: #10 x 1-1/2" Flat head wood screws

Options: Available with Sure Step non-slip abrasive coating

Notes:

- MIL finish thresholds are supplied with zinc plated screws
- Color anodized thresholds are supplied with screws plated to match

442S

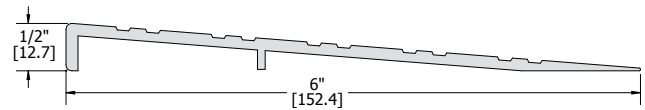

Finishes: MIL, DBA, GLD
 Certifications:

443S

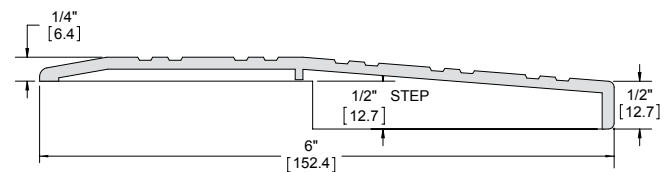

Finishes: MIL, DBA, GLD
 Certifications:

444S

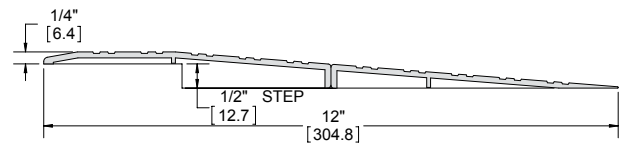

Finishes: MIL, DBA, GLD
 Certifications:

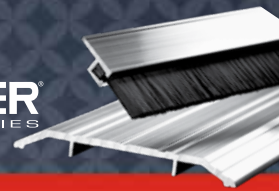

THRESHOLDS - FLOOR PLATE ASSEMBLY

Floor plate components for modular threshold system. Used primarily for extra wide door frames or to cover expansion joints or floor joists

Fasteners: Plates and plate supports are furnished without holes and fasteners unless specified

Options:

- Available with Sure Step non-slip abrasive coating
- Beveled Edges are available

Notes: Plates may be used fluted or smooth side up

Typical Applications

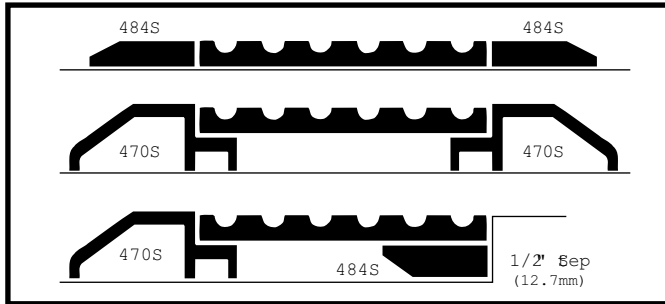

455S

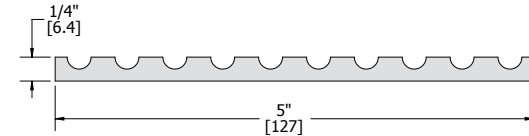

Finishes: MIL, DBA, GLD

Certifications:



460S

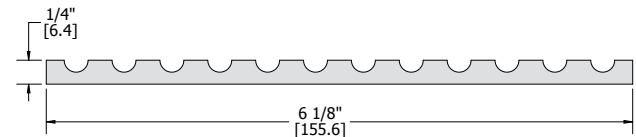

Finishes: MIL, DBA, GLD

Certifications:



440S

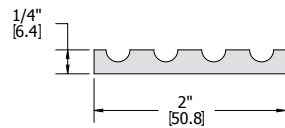

Finishes: MIL, DBA, GLD

Certifications:



465S

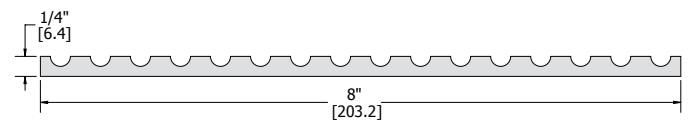

Finishes: MIL, DBA, GLD

Certifications:



445S

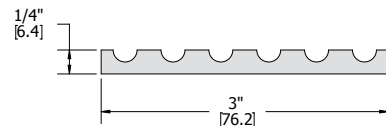

Finishes: MIL, DBA, GLD

Certifications:



470S

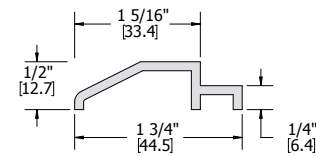

Finishes: MIL, DBA, GLD

Certifications:



450S

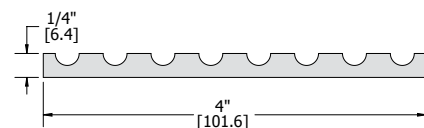

Finishes: MIL, DBA, GLD

Certifications:



484S

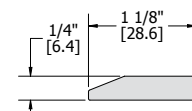

Finishes: MIL, DBA, GLD

Certifications:



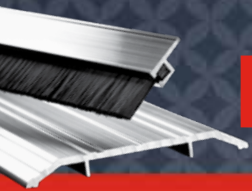

THRESHOLDS - PANIC

- Use in conjunction with surface applied vertical rod exit device
- Fasteners: #10 x 1-1/2" flat head sheet metal screws, other screw types and anchors available upon request
- Options: Available with Sure Step non-slip abrasive coating
- Notes:
 - MIL finish thresholds are supplied with zinc plated screws
 - Color anodized thresholds are supplied with screws plated to match
 - Special under cuts may be required

Typical Applications

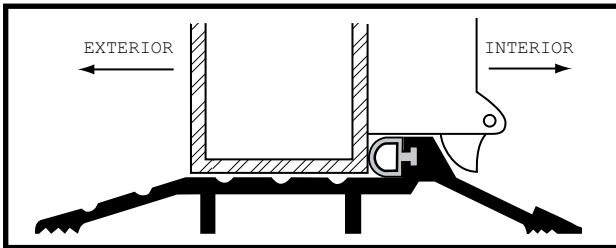

520S

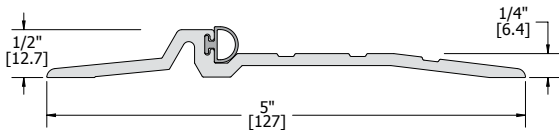

- Finishes: MIL, DBA, GLD
 Inserts: V, N, S, W
 Door Undercut: Allow 3/8"



541S

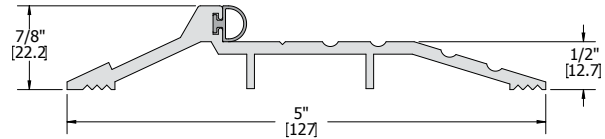

- Finishes: MIL, DBA, GLD
 Inserts: V, N, S, W
 Door Undercut: Allow 5/8"



552S

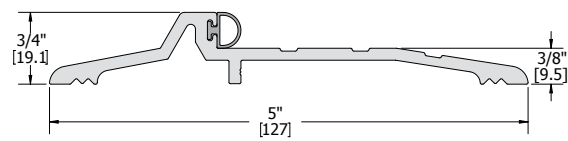

- Finishes: MIL, DBA, GLD
 Inserts: V, N, S, W
 Door Undercut: Allow 1/2"



560S

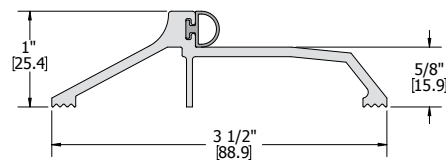

- Finishes: MIL, DBA, GLD
 Inserts: V, N, S, W
 Door Undercut: Allow 3/4"



532S

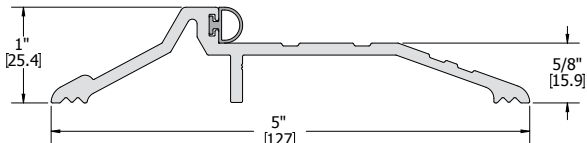

- Finishes: MIL, DBA, GLD
 Inserts: V, N, S, W
 Door Undercut: Allow 3/4"



565S

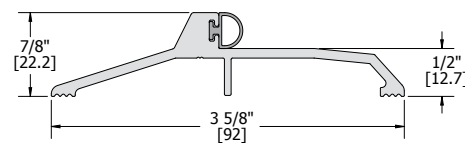

- Finishes: MIL, DBA, GLD
 Inserts: V, N, S, W
 Door Undercut: Allow 5/8"



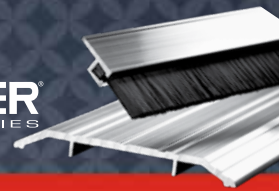

THRESHOLDS - PANIC

575S

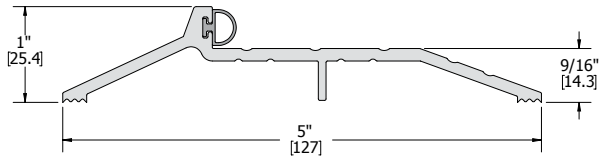

Finishes: MIL, DBA, GLD
 Inserts: V, N, S, W
 Door Undercut: Allow 11/16"
 Certifications: 

580S

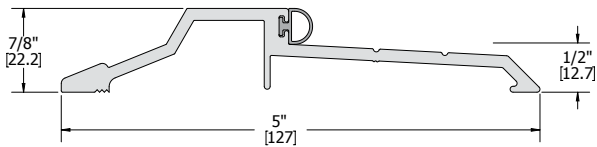

Finishes: MIL, DBA, GLD
 Inserts: V, N, S, W
 Door Undercut: Allow 5/8"
 Certifications: 

599S

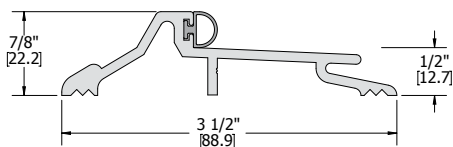

Finishes: MIL, DBA, GLD
 Inserts: V, N, S, W
 Door Undercut: Allow 5/8"
 Certifications: 

THRESHOLDS - THERMAL BARRIER PANIC

Threshold for latching panic devices that have a thermal barrier permanently bonded in place to effectively block the transfer of heat or cold. Use in conjunction with surface applied vertical rod exit device.

Fasteners: #10 x 1-1/2" Flat head sheet metal screws, other screw types and anchors available upon request

Options: Available with Sure Step non-slip abrasive coating

Notes:

- MIL finish thresholds are supplied with zinc plated screws
- Color anodized thresholds are supplied with screws plated to match

516S

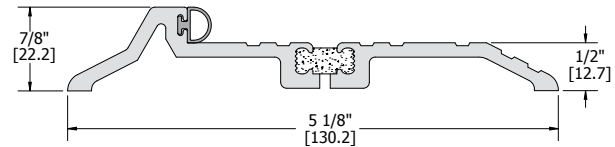

Finishes: MIL, DBA, GLD
 Inserts: V, N, S, W
 Certifications: 

518S

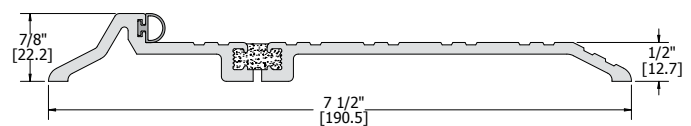

Finishes: MIL, DBA, GLD
 Inserts: V, N, S, W
 Certifications: 

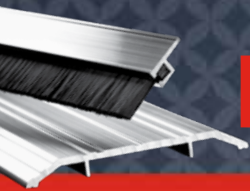

THRESHOLDS - INTERLOCKING

Threshold interlocks with hook on the bottom of the door for a superior seal against wind and rain

Fasteners: #10 x 1-1/2" Flat head sheet metal screws, other screw types and anchors available upon request

Options: Available with Sure Step non-slip abrasive coating

- Notes:
- MIL finish thresholds are supplied with zinc plated screws
 - Color anodized thresholds are supplied with screws plated to match
 - Thresholds are supplied with the 701S J-Hook
 - Metal doors must have flush bottom for proper J-hook installation

600S

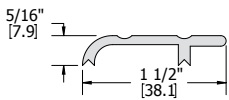

Finishes: MIL, DBA, GLD

Certifications:

701S

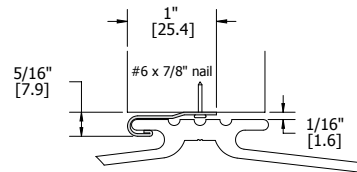

Finishes: MIL
Fasteners: #6 x 7/8" nail
Certifications:

Notes: J-Hook interlocks with threshold to seal against wind and rain

604S

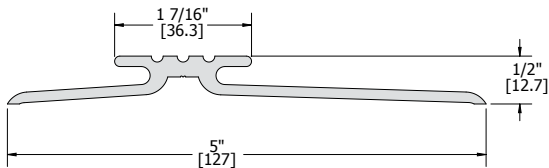

Finishes: MIL, DBA

Certifications:



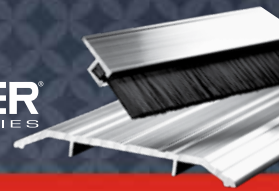

THRESHOLDS- ABRASIVE CAST ALUMINUM

A heavy duty aluminum threshold with silicon carbide granules integrally cast into the surface. Ideal for high traffic areas where maximum durability is required. The abrasive, skid resistant surface works well under wet, dry or oily conditions.

Fasteners: #1/4" flat head zinc plated sheet metal screws with lead anchor

Options: Cast-on anchors available upon request

- Notes:
- Furnished with countersunk holes
 - Cut with a reinforced abrasive plain surface disk, 1/8" thick, either aluminum oxide or silicon carbide
 - Maximum length available is 8 feet, not available for floor closers
 - Available in 4", 5" and 6" widths

626S

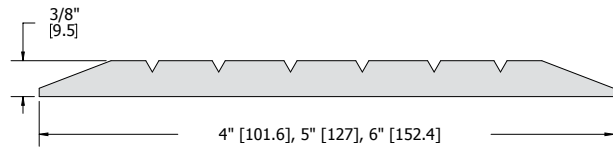

Finishes:

CAL

Certifications:



627S

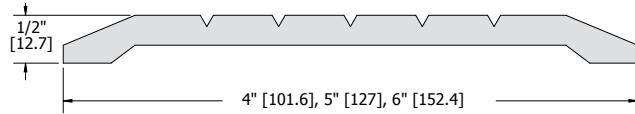

Finishes:

CAL

Certifications:



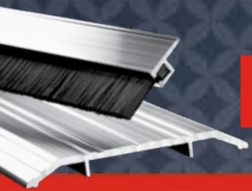

THRESHOLDS - FLOOR CLOSER

Used with floor closers on center or offset hung door applications.

Fasteners: #10 x 1-1/2" flat head sheet metal screws, other screw types and anchors available upon request

Options: Available with Sure Step non-slip abrasive coating

Order: Specify closer manufacturer, offset, closer model number, thickness of door, width of door opening and handing

Notes:

- MIL finish thresholds are supplied with zinc plated screws
- Color anodized thresholds are supplied with screws plated to match

651S - Center Hung

1/2" x 7"
[12.7 x 177.8]

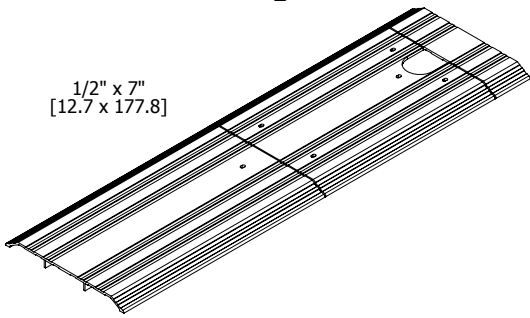

Finishes:

MIL, DBA

Certifications:



Notes:

- Center hung
- Without mitered ends

652S - Center Hung

1/2" x 5"
[12.7 x 127]

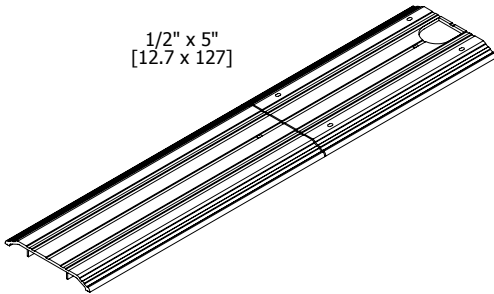

Finishes:

MIL, DBA

Certifications:



Notes:

- Center hung
- Without mitered ends



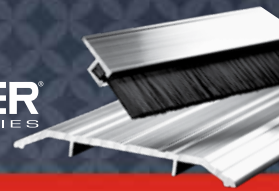

THRESHOLDS - COVER PLATES AND VINYL THRESHOLDS

Cover Plates are used primarily to cover expansion joints and for situations requiring extra width or strength. Manufactured from solid cold rolled aluminum for extra durability.

Fasteners: Furnished without holes and fasteners unless specified

Notes:

- Available to 96" in length
- Furnished with both edges beveled

676S



Finishes:
Certifications:



677S

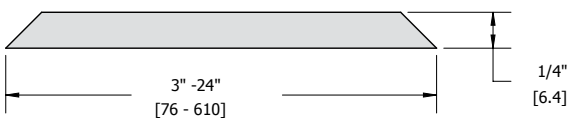

Finishes:
Certifications:



Vinyl Thresholds

Transition between different floor types.

900S

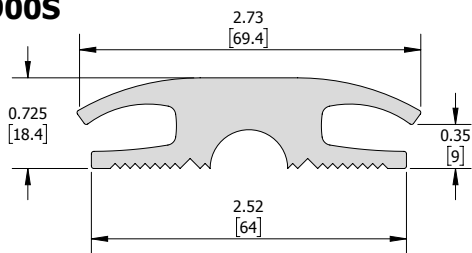

Finishes:
Certifications:



Notes: Transition between carpet to carpet applications.

901S

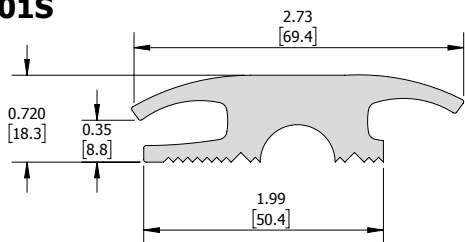

Finishes:
Certifications:



Notes: Transition between carpet to tile applications.

902S

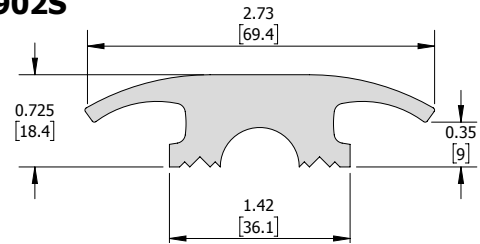

Finishes:
Certifications:



Notes: Transition between tile to tile applications.

903S

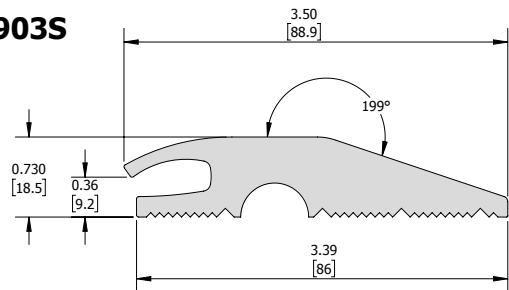

Finishes:
Certifications:



Notes: Transition to carpet.

904S

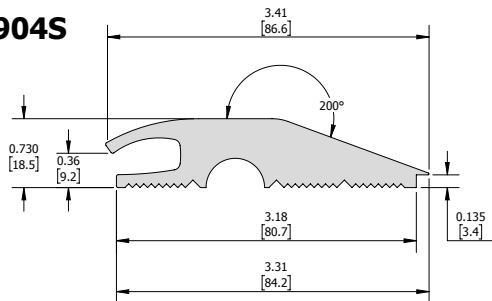

Finishes:
Certifications:



Notes: Transition between carpet to tile applications.

905S

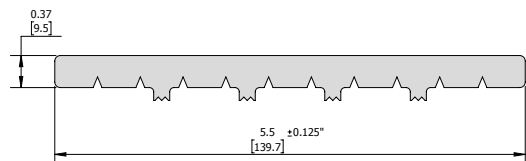

Finishes:
Certifications:



Notes: Transition between communicating door frames.

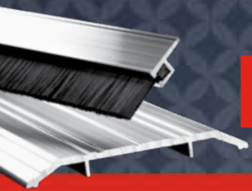

WEATHERSTRIPPING - INTERLOCKING/OVERHEAD DRIP GUARDS

Fasteners: #6 x 5/8" pan head sheet metal screws

717S

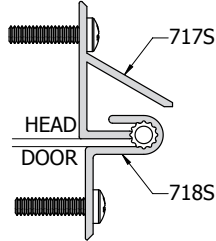
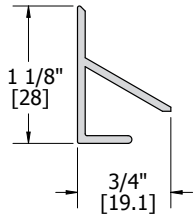

Finishes:
Certifications:

MIL, DBA

709S

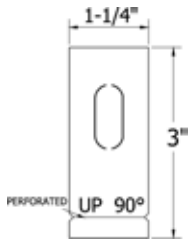

Finish:
Certifications:

Black

810S

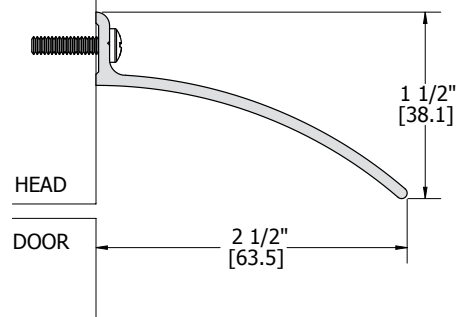

Finishes:
Certifications:

MIL, DBA, GLD

770S

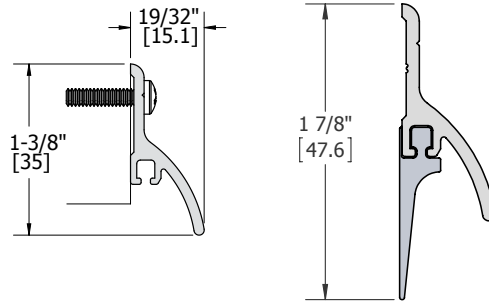

Finishes:
Inserts:
Category:
Certifications:

MIL, DBA, GLD
 B, V, or without insert
 H, J (with insert)



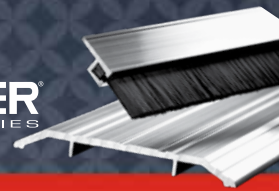

WEATHERSTRIPPING - PRESS-ON GASKETING

Adhesive Mullion Seal

710S

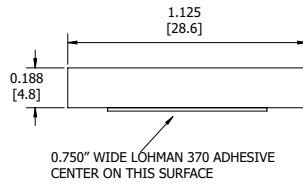

Finishes:
Category:
Certifications:



Notes:
• Sponge Neoprene

734

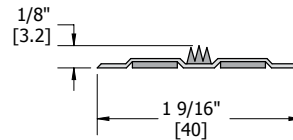

Finishes: Charcoal, Brown
Category: H, G, J

Certifications:   



Notes:
• Intumescent material
• Thermoplastic Elastomer (TPE) material

Combination Edge-Sealing System with Smoke Control

Field applied edge-sealing system gaskets with integrated smoke fin. Add to the frame of a B, C or 1/3 hour labeled fire door.

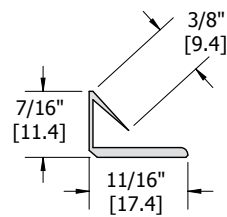
719



Finishes: Charcoal, Brown
Category: H, G, J
Certifications:   

Notes:
• Requires 1/8" clearance
• Not recommended for door frames with 1/2" stop or less
• Recommend 3/16" backset - door side hinge
• Intumescent material
• Thermoplastic Elastomer (TPE) material

Edge-Sealing Systems

Field applied edge-sealing system gaskets. Add to the frame of a B, C or 1/3-hour labeled fire doors to comply with positive pressure requirements.

721

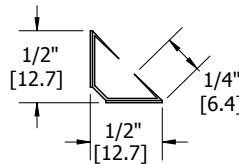





Finishes: Charcoal, Brown, Gray, White
Category: H, J

Certifications:     

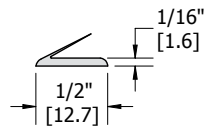
Notes: Thermoplastic Elastomer (TPE) material

720



Finishes: Charcoal, Brown, White
Category: H, G, J
Certifications:   

Notes:
• Thin design for doors and frames with tight tolerances
• Intumescent material
• Thermoplastic Elastomer (TPE) material

724

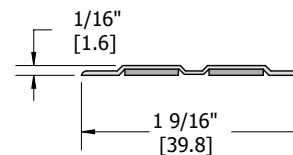





Finishes: Charcoal, Brown
Category: G

Certifications:  

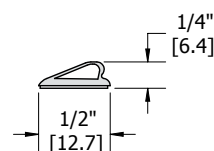
Notes:
• Intumescent material
• Thermoplastic Elastomer (TPE) material

722



Finishes: Charcoal, Brown
Category: H, G, J
Certifications:   

Notes:
• Requires 1/8" clearance.
• Recommend 3/16" backset - door side hinge
• Intumescent material
• Thermoplastic Elastomer (TPE) material

729

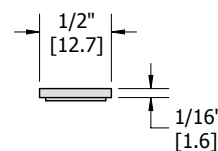

Finishes: Charcoal, Brown, White
Category: G

Certifications:  

Notes:
• Intumescent material
• Thermoplastic Elastomer (TPE) material

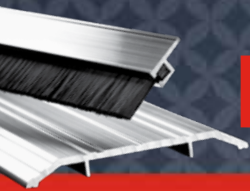

WEATHERSTRIPPING - PRESS-ON GASKETING

Smoke Seal Systems

Add to the frame of a smoke rated opening to comply with the requirements of NFPA 80, 105, and UL1784. The addition of a smoke seal is necessary to complete installation instructions and validate the "S" label of a smoke control door.

726

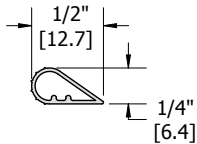

Finishes:
Category:
Certifications:

Charcoal, Brown, Tan, White
H, J



Notes:

Silicone material

736

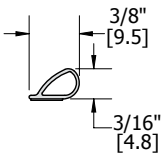

Finishes:
Category:
Certifications:

Charcoal, White
H, J



Notes:

Silicone material

737

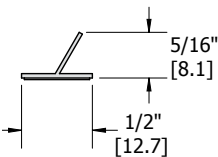

Finishes:
Category:
Certifications:

Charcoal
H, J



Notes:

Silicone material

Draft Control Gaskets

725

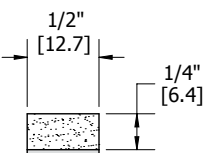

Finishes:
Category:
Certifications:

Charcoal
J



Notes:

Sponge neoprene material

728

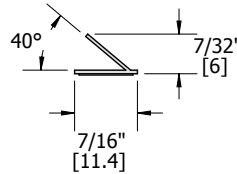

Finishes:
Category:
Certifications:

Charcoal
J



Notes:

Silicone material

738

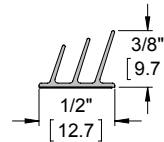

Finishes:
Category:
Certifications:

Charcoal
J



Notes:

Silicone material

739

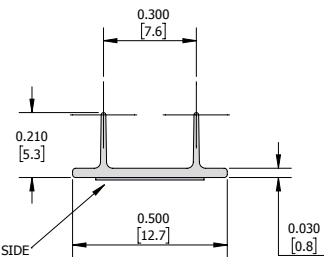

Finishes:
Category:
Certifications:

Brown, Clear
H, J



Notes:

Silicone material



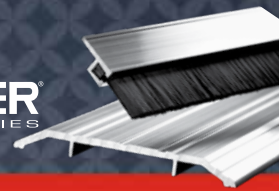

WEATHERSTRIPPING - DOOR BOTTOMS

Provides a seal against weather. For best results, use in conjunction with a threshold.



Fasteners: #6 x 5/8" pan head sheet metal screws

Notes:

- Lengths up to 48" are supplied 1/2" over their stated size to allow for fitting
- Lengths over 48" are supplied 1" over size
- "Cut to exact length," may be specified
- Constructed of strong extruded 6063-T5 aluminum

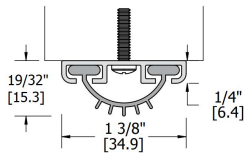

774S



Finishes: MIL, DBA
 Inserts: V, N
 Category: H, J
 Certifications:   

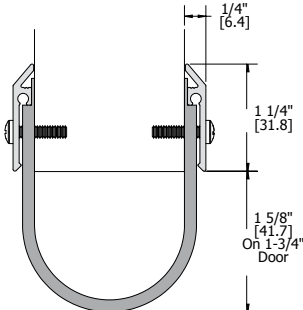

776S



Finishes: CLR, DBA, GLD
 Inserts: N
 Category: H, J
 Certifications:  

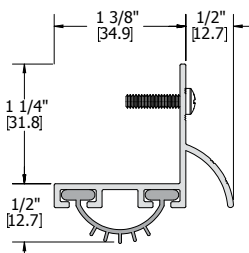

777S

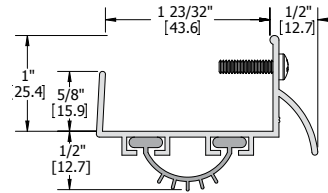

Finishes: MIL, DBA, GLD
 Inserts: V, N
 Category: H, J
 Certifications:  

778S



Finishes: MIL, DBA, GLD
 Inserts: V, N
 Category: H, J
 Certifications:  

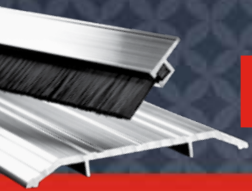

WEATHERSTRIPPING - DOOR BOTTOMS

779S

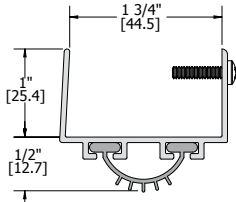

Finishes: MIL, DBA, GLD
 Inserts: V, N
 Category: H, J
 Certifications:

783S

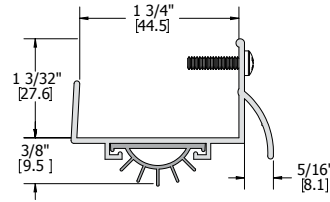

Finishes: MIL, DBA, GLD
 Inserts: V
 Category: J
 Certifications:

780S

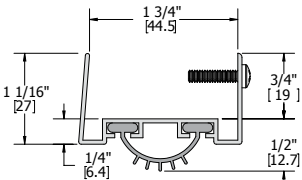

Finishes: MIL, DBA, GLD
 Inserts: V, N
 Category: H, J
 Certifications:

787S

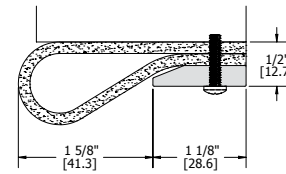

Finishes: MIL
 Inserts: N
 Category: H, J
 Certifications:

782S

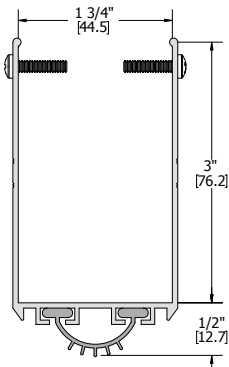

Finishes: MIL, DBA, GLD
 Inserts: V, N
 Category: H, J
 Certifications:

789S

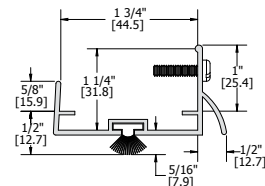

Finishes: MIL, DBA, GLD
 Inserts: W
 Category: H, J
 Certifications:

906S

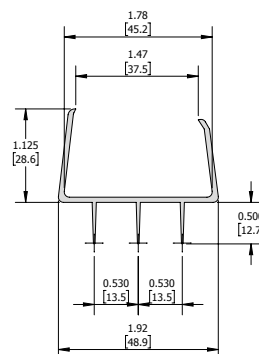

Finishes: Brown
 Material: PVC
 Certifications:
 *Unnotched & Notched profiles available



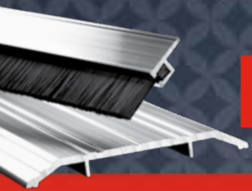

WEATHERSTRIPPING - DOOR BOTTOMS

907S

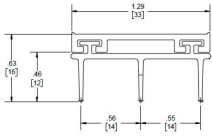

Finishes: MIL, DBA, GLD
 Insert: V
 Certifications: 
 *Unnotched & Notched profiles available

908S

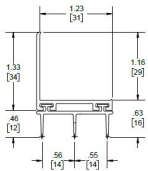

Finishes: MIL, DBA, GLD, CLR
 Insert: V
 Certifications: 
 *Unnotched & Notched profiles available

909S

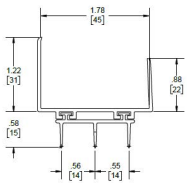

Finishes: MIL, DBA, GLD, CLR
 Insert: V
 Certifications: 
 *Unnotched & Notched profiles available



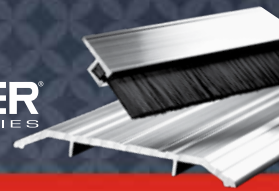

WEATHERSTRIPPING - AUTOMATIC DOOR BOTTOMS

Provides an outstanding seal against drafts, light, smoke and sound. For best results, use in conjunction with a threshold. When door fully closes, the gasket extends downward to provide a seal. Gasket retracts when door is opened.

- Fasteners:
- #8 x 1-1/4" pan head sheet metal screws furnished with surface mount types
 - #6 x 5/8" Pan head sheet metal screws furnished with mortise types
- Notes:
- Furnished exact length as stated.
 - Furnished with end cover and strike plates
 - DBA/GLD end caps available on MIL or CLR devices (Not available on 742S)

730S - Mortise

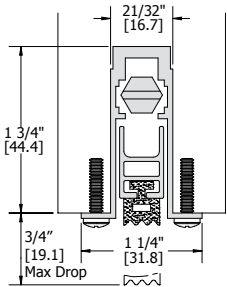

Finishes:
Inserts:
Category:
Certifications:

Notes:

MIL
N, S
H, J



Available order lengths:
12" to 60".
Lengths 16"-29" may be trimmed for fitting (2" maximum).
Lengths 30"-60" may be trimmed for fitting (5" maximum).

742S - Mortise

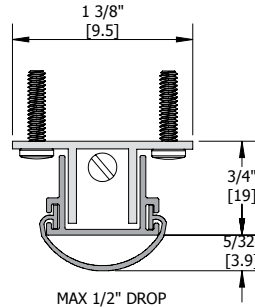

Finishes:
Inserts:
Category:
Certifications:

Notes:

MIL
V
J



For use on hollow metal door
Available order lengths:
24" to 60".
24" cannot be trimmed.
36" to 48" can be trimmed up to 3".
All other sizes can be trimmed up to 1".

743S - Mortise

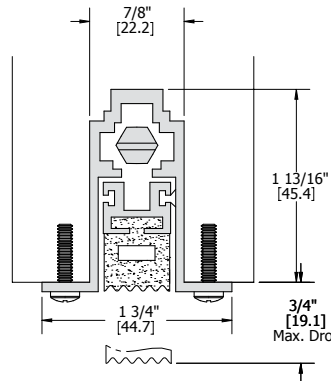

Finishes:
Inserts:
Category:
Certifications:

Notes:

MIL
N
H, J



Available order lengths:
12" to 60".
Lengths 16"-29" may be trimmed for fitting (2" maximum).
Lengths 30"-60" may be trimmed for fitting (5" maximum).

740S - Surface

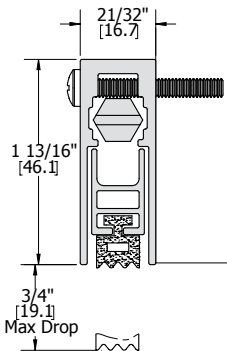

Finishes:
Inserts:
Category:
Certifications:

Notes:

DBA, GLD, CLR
N, S
H, J



Available order lengths:
12" to 60".
Lengths 16"-29" may be trimmed for fitting (2" maximum).
Lengths 30"-60" may be trimmed for fitting (5" maximum).

747S - Surface

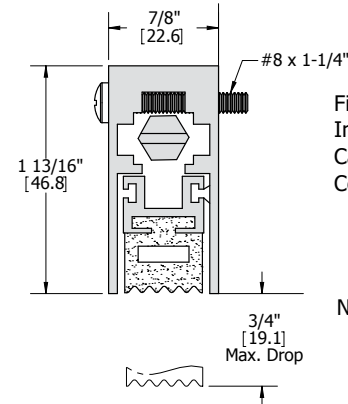

Finishes:
Inserts:
Category:
Certifications:

Notes:

CLR, DBA, GLD
N
H, J



Available order lengths:
12" to 60".
Lengths 16"-29" may be trimmed for fitting (2" maximum).
Lengths 30"-60" may be trimmed for fitting (5" maximum).

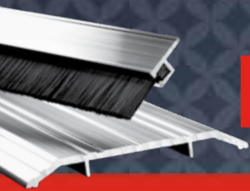

WEATHERSTRIPPING - DOOR BOTTOM SWEEPS

Typically door bottom sweeps are used on the exterior of an outswing door
Fasteners: #6 x 5/8" pan head sheet metal screws furnished with mortise types

- Notes:
- MIL finish weatherstripping is supplied with zinc plated screws
 - Color anodized weatherstripping is supplied with screws plated to match
 - Stainless steel weatherstripping is supplied with stainless steel screws

750S

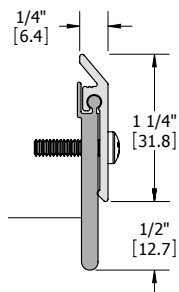

Finishes: DBA, GLD, CLR, US32D
Inserts: N, S
Category: H, J

Certifications:

752S

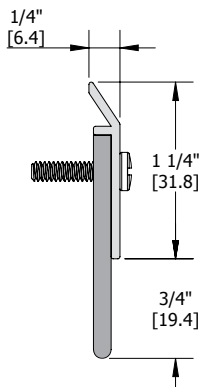

#6 x 5/8" PAN HEAD SHEET METAL SCREWS (FACTORY PROVIDED)

Finishes: MIL, DBA, GLD
Inserts: V
Category: H, J

Certifications:

753S

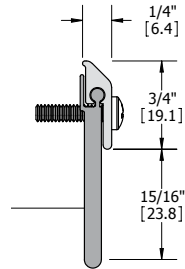

Finishes: MIL, DBA, GLD
Inserts: N
Category: H, J

Certifications:

754S

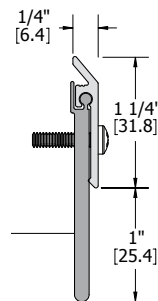

Finishes: DBA, GLD, CLR
Inserts: N
Category: H, J

Certifications:

756S

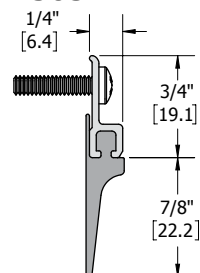

Finishes: MIL, DBA, GLD
Inserts: V
Category: H, J

Certifications:



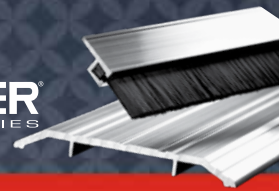

WEATHERSTRIPPING - DOOR BOTTOM SWEEPS

759S

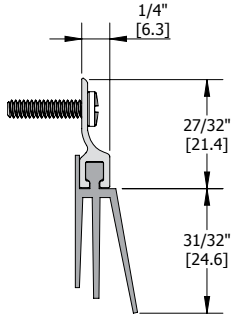

Finishes: MIL, DBA, GLD
 Inserts: V
 Category: H, J
 Certifications:



802S

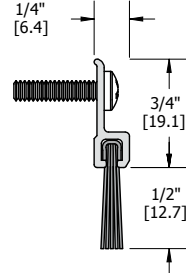

Finishes: MIL, DBA, GLD
 Inserts: B
 Category: H, J
 Certifications:



770S

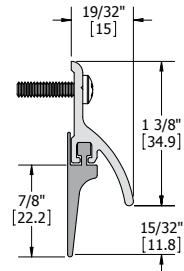

Finishes: MIL, DBA, GLD
 Inserts: B, V
 Category: H, J
 Certifications:



806S

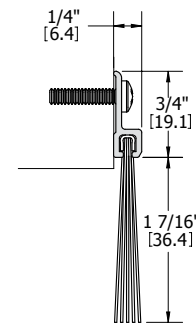

Finishes: MIL, DBA, GLD
 Inserts: B
 Category: H, J
 Certifications:



801S

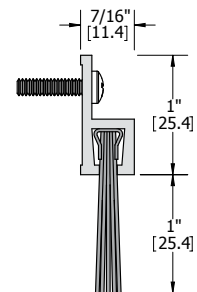

Finishes: MIL, DBA, GLD
 Inserts: B
 Category: H, J
 Certifications:



872S

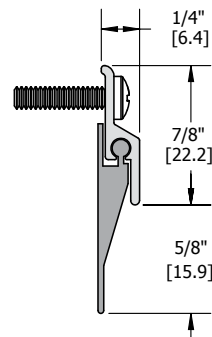

Finishes: DBA, GLD, CLR
 Inserts: N
 Category: H, J
 Certifications:



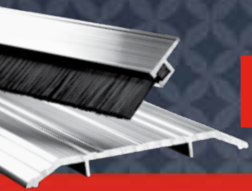

WEATHERSTRIPPING - DOOR BOTTOM SWEEPS

882S

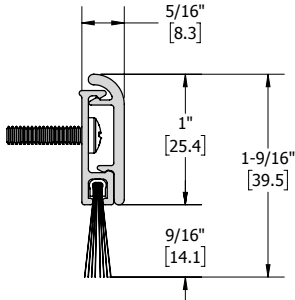

Finishes: DBA, GLD, CLR
 Inserts: B
 Category: H, J
 Certifications:

884S

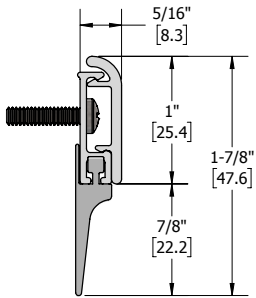

Finishes: DBA, GLD, CLR
 Inserts: V
 Category: H, J
 Certifications:

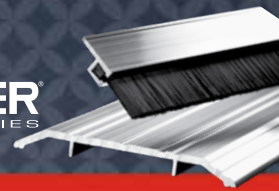



WEATHERSTRIPPING - ADJUSTABLE JAMB WEATHERSTRIPPING

- Fasteners: #6 x 5/8" pan head sheet metal screws
- Notes:
- MIL finish weatherstripping is supplied with zinc plated screws
 - Color anodized weatherstripping is supplied with screws plated to match
 - Stainless steel weatherstripping is supplied with stainless steel screws

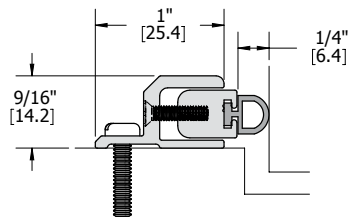

860S



- Finishes: MIL, DBA, GLD
- Inserts: V, N, S, W
- Category: H, J
- Certifications:   
- Notes: Adjustable

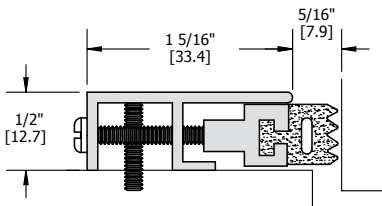

864S



- Finishes: DBA, GLD, CLR
- Inserts: N
- Category: H, J
- Certifications:  
- Notes: Adjustable

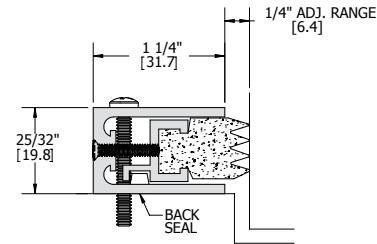

865S

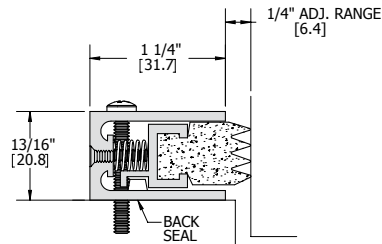

- Finishes: MIL, DBA, GLD
- Inserts: N
- Category: H, J
- Certifications:  
- Notes: Adjustable

866S



- Finishes: MIL, DBA
- Inserts: N
- Category: H, J
- Certifications:   
- Notes: Spring adjustable

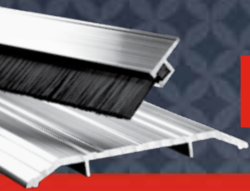

WEATHERSTRIPPING - JAMB WEATHERSTRIPPING

Fasteners: 8-32 x 1" pan head phillips machine screws
8-18 x 1" undercut flat head phillips sheet metal screws

- Notes:**
- MIL finish weatherstripping is supplied with zinc plated screws
 - Color anodized weatherstripping is supplied with screws plated to match
 - Stainless steel weatherstripping is supplied with stainless steel screws

785S

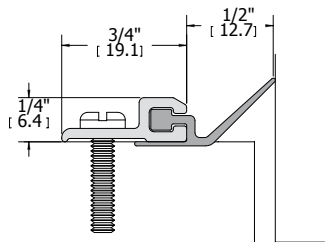

Finishes: MIL, DBA, GLD
Inserts: N
Category: H, J
Certifications:

800S

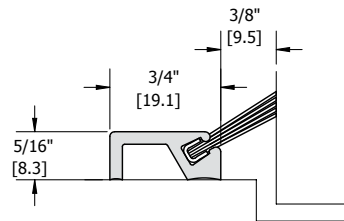

Finishes: MIL, DBA, GLD
Inserts: B
Category: H, J
Certifications:

802S

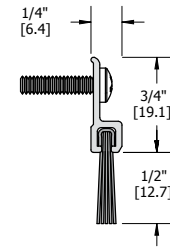

Finishes: MIL, DBA, GLD
Inserts: B
Category: H, J
Certifications:

803S

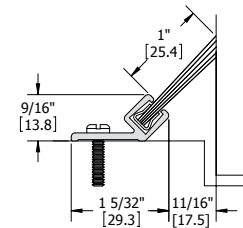

Finishes: MIL, DBA, GLD
Inserts: B
Category: H, J
Certifications:

808S

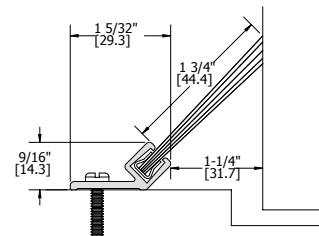

Finishes: MIL, DBA, GLD
Inserts: B
Category: H, J
Certifications:



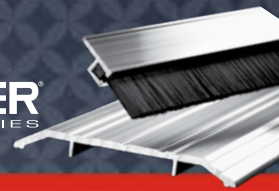



WEATHERSTRIPPING - JAMB WEATHERSTRIPPING

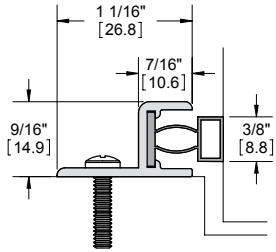

859S

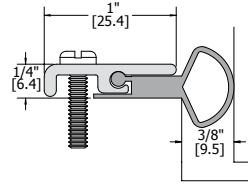

Finishes: MIL, DBA
 Category: H, J
 Certifications:  
 Notes: Magnetic

863S



Finishes: DBA, GLD, CLR
 Inserts: N
 Category: H, J
 Certifications:  

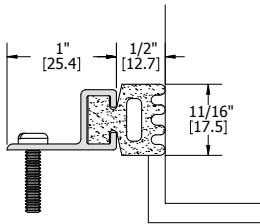

861S



Finishes: MIL, DBA, GLD
 Inserts: N
 Category: H, J
 Certifications:   

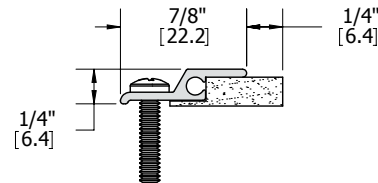

870S

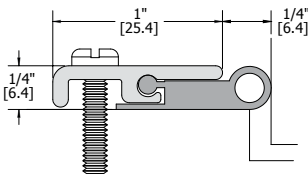

Finishes: DBA, GLD, CLR
 Inserts: N
 Category: H, J
 Certifications:   
 Notes: Adjustable

862S



Finishes: DBA, GLD, CLR
 Inserts: N
 Category: H, J
 Certifications:   

871S

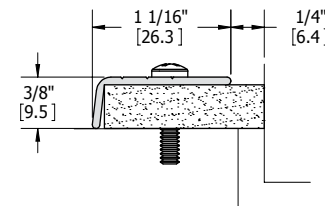

Finishes: MIL, DBA, GLD
 Inserts: N
 Category: H, J
 Certifications:  

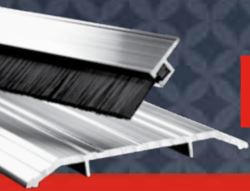

WEATHERSTRIPPING - JAMB WEATHERSTRIPPING

873S

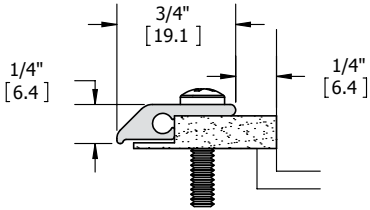

Finishes: MIL, DBA, GLD
 Inserts: N
 Category: H, J
 Certifications:



877S

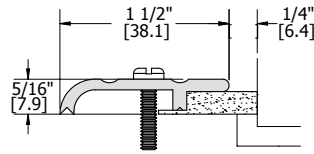

Finishes: MIL, DBA, GLD
 Inserts: N
 Category: H, J
 Certifications:



874S

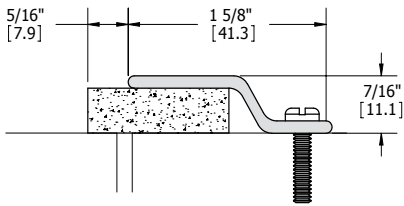

Finishes: MIL, DBA, GLD, US32D
 Inserts: N
 Category: H, J
 Certifications:



878S

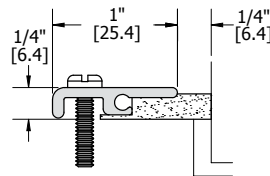

Finishes: DBA, GLD, CLR
 Inserts: N
 Category: H, J
 Certifications:



875S

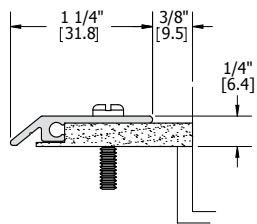

Finishes: DBA, GLD, CLR
 Inserts: N, S
 Category: H, J
 Certifications:



880S

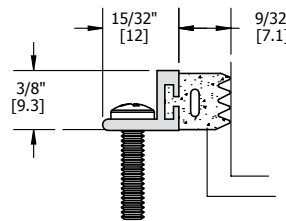

Finishes: MIL, DBA, GLD
 Inserts: N
 Category: H, J
 Certifications:



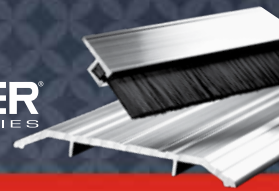

WEATHERSTRIPPING - JAMB WEATHERSTRIPPING

882S

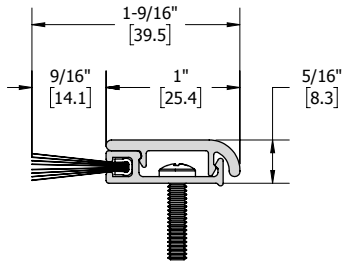

Finishes: DBA, GLD, CLR
 Inserts: B
 Category: H, J
 Certifications:  

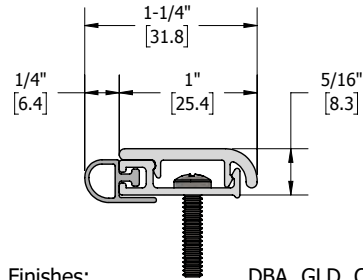

885S



Finishes: DBA, GLD, CLR
 Inserts: V, N, S, W
 Category: H, J
 Certifications:  

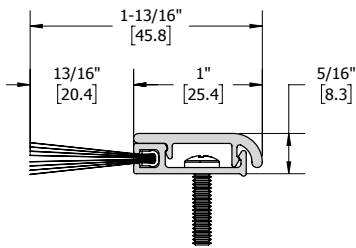

883S



Finishes: DBA, GLD, CLR
 Inserts: B
 Category: H, J
 Certifications:  

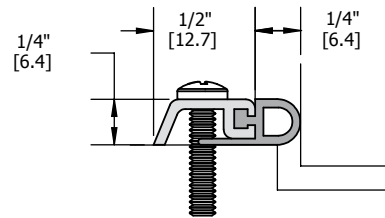

890S



Finishes: MIL, DBA, GLD
 Inserts: V, N, S
 Category: H, J
 Certifications:  

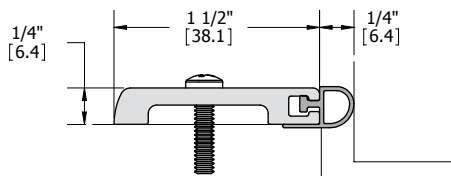

881S

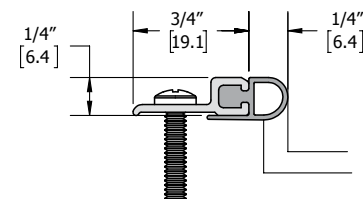

Finishes: MIL, DBA, GLD
 Inserts: V, N, S, W
 Category: H, J
 Certifications:  

891S



Finishes: MIL, DBA, GLD
 Inserts: V, N, S
 Category: H, J
 Certifications:  

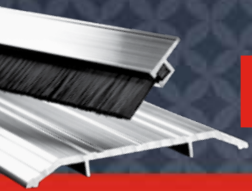

WEATHERSTRIPPING - JAMB WEATHERSTRIPPING

892S

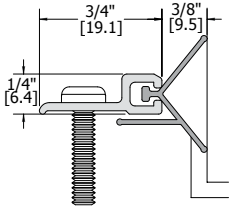

Finishes: MIL, DBA, GLD
 Inserts: N
 Category: H, J
 Certifications:  

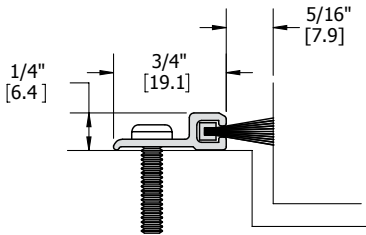

893S

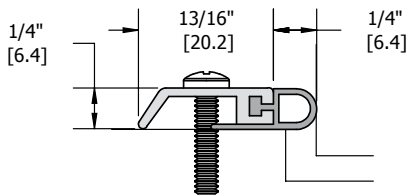

Finishes: MIL, DBA, GLD
 Inserts: W
 Category: J
 Certifications:   

896S



Finishes: MIL, DBA, GLD
 Inserts: V, N, S
 Category: H, J
 Certifications:   

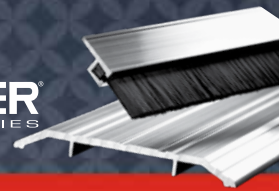

WEATHERSTRIPPING - ASTRAGALS/MEETING STILES

Fire labeled Astragals & Meeting Stiles should only be mounted on pairs of doors with a gap that meets NFPA 80 2-3.1.7 (1/8" +/- 1/16" for steel doors and not exceeding 1/8" for wood doors)

Fasteners: #6 x 5/8" Pan head sheet metal screws

Notes:

- MIL finish weatherstripping is supplied with zinc plated screws
- Color anodized weatherstripping is supplied with screws plated to match
- Stainless steel weatherstripping is supplied with stainless steel screws

772S

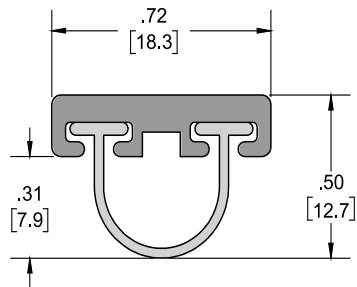

Finishes:
Inserts:
Category:
Certifications:

MIL, DBA, GLD
N, W
H, J



771S

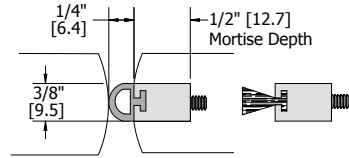

Finishes:
Inserts:
Category:
Certifications:

MIL, DBA
V, W, N, S
J



Notes:

Order two (2) for a set

756S

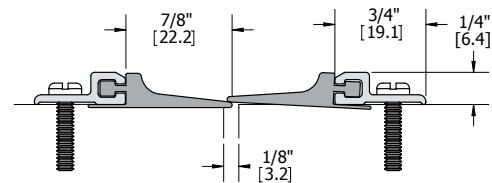

Finishes:
Inserts:
Category:
Certifications:

MIL, DBA, GLD
V
H, J



Notes:

Order two (2) for a set

774S

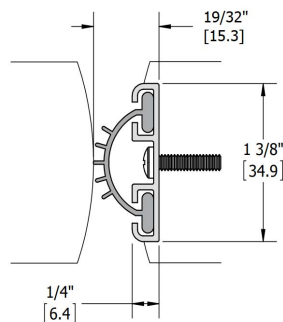

Finishes:
Inserts:
Category:
Certifications:

MIL, DBA
V, N
H, J



WEATHERSTRIPPING - ASTRAGALS/MEETING STILES

776S

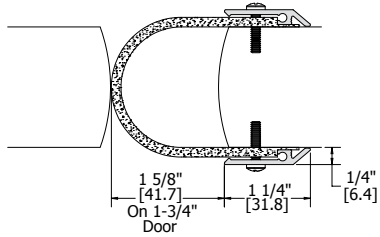

Finishes: DBA, GLD, CLR
 Inserts: N
 Category: H, J
 Certifications:  

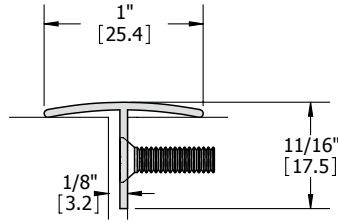

836S

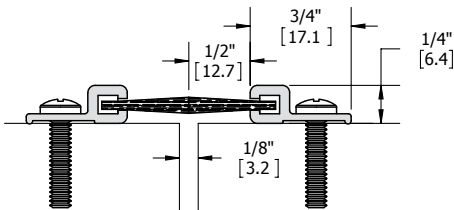

Finishes: MIL, DBA, GLD
 Category: H, J
 Certifications: 

802S



Finishes: MIL, DBA, GLD
 Inserts: B
 Category: H, J
 Certifications:  
 Notes: Order two (2) for a set

837S

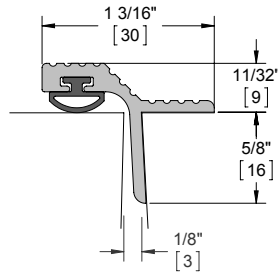

Finishes: MIL, DBA, GLD
 Inserts: W, V, N, S
 Category: H, J
 Certifications:  

835S

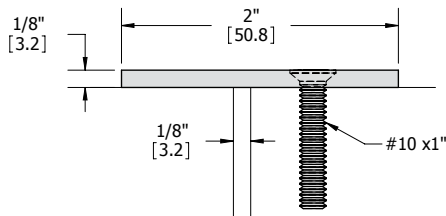

Finishes: MIL, DBA, GLD, US32D, USP
 Category: J
 Certifications:  

Notes:

- Maximum length = 10 feet
- Available with thrubolts

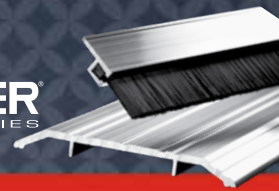

WEATHERSTRIPPING - ASTRAGALS/MEETING STILES

839S

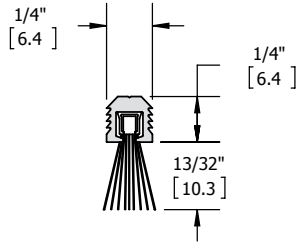

Finishes: MIL
 Inserts: W
 Category: J
 Certifications: 

849S

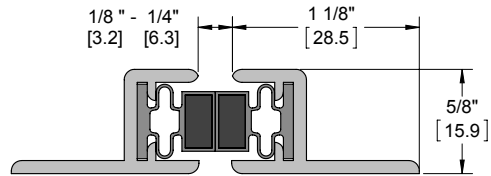

Finishes: MIL, DBA
 Notes:

- Magnetic
- 96" maximum door height
- Designed for use on 80" to 96" doors only
- Sets shorter than 80" may not work properly

845S | 846S

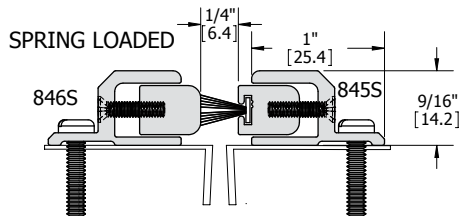



Finishes: MIL, DBA, GLD
 Inserts: W
 Category: J
 Certifications: 

Notes:

- Adjustable
- Order two (2) for a set

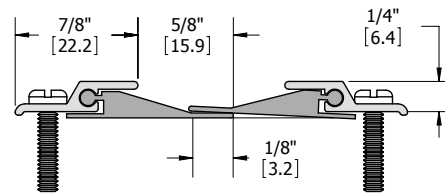
872S





Finishes: DBA, GLD, CLR
 Inserts: N
 Category: H, J
 Certifications:  

Notes:

- Order two (2) for a set

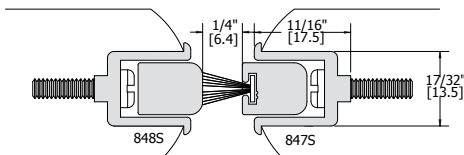
847S | 848S



Finishes: MIL, DBA, GLD
 Inserts: W
 Category: J
 Certifications: 

Notes:

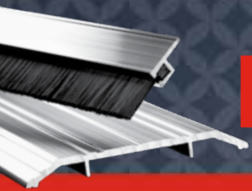

- Adjustable
- Spring loaded
- Mortise depth = 21/32"



WEATHERSTRIPPING - ASTRAGALS/MEETING STILES

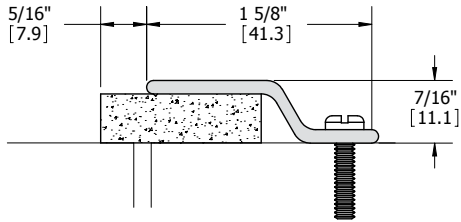

874S

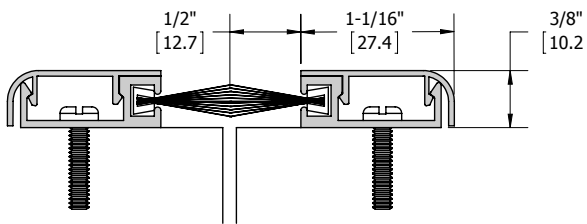

Finishes: MIL, DBA, GLD, US32D
 Inserts: N
 Category: H, J
 Certifications:  

882S



Finishes: DBA, GLD, CLR
 Inserts: B
 Category: H, J
 Certifications:  
 Notes: Order two (2) for a set